



CENTURY III

AUTOPILOT FLIGHT SYSTEM

PILOT'S OPERATING HANDBOOK

NOVEMBER 1998
68S25

NOTICE

This manual contains General Information on operation of Century III Autopilot. specific FAA approved information on Special Techniques, Limitations and Emergency Procedures for a particulate model airplane are contained in either an Airplane Flight Manual Supplement or a placard. Be sure and familiarize yourself with the information contained therein before flight.

REVISION LOG

Original dated March 1981

Revision 1 dated November 1998

Pages and Figure Drawings renumbered and book reformatted in computer.

INTRODUCTION

The Century Flight Systems, Inc. Century III is a light weight (18 lbs.) automatic flight system utilizing an advanced electronic design for maximum performance and utility. Operating on the versatile and adaptable 5000 cycle audio frequency, the Century Flight Systems, Inc. Century III represents a new design concept in which the conventional follow up, or control position feed back signals, are replaced by solid state analytical computers. In addition to providing a more stable and adaptable auto-pilot platform for advanced navigational coupling, this new system can cope with uneven fuel loads directional mis-trim and power changes without the usual directional errors, altitude losses, or command change requirements.

Roll and pitch responses are time controlled for human-like control action and smooth attitude transactions.

This manual describes the basic characteristics of each control function and its relationship to other functions in the flight system. Maximum utility will be realized after familiarization and practice.

TABLE OF CONTENTS

NOTICE	2
REVISION LOG	3
INTRODUCTION	4
TABLE OF CONTENTS	5
COMMAND CONSOLE	6
Roll (Aileron) Engagement	6
Roll Command Knob	7
Heading Mode.....	7
Course Selector.....	7
Aircraft Trim Effects.....	8
Trim Indicator and Pitch Command Wheel	8
Pitch (Elevator) Engagement.....	9
Altitude Hold	9
AUTOMATIC TRIM OPERATIONS	10
GENERAL OPERATIONS.....	10
Pilots Preflight Procedures	11
Trim Check.....	12
AIR FILTER	13
Filter and Element	13
LATERAL GUIDANCE SYSTEM.....	14
Omni Mode.....	15
Nav Mode	15
Heading Mode.....	16
Localizer (Normal) Mode.....	16
Localizer (Reverse) Mode	16
Lateral Guidance System Operation.....	17
VOR Navigation	18
VOR Approach.....	20
ILS Approach - Normal.....	22
ILS Approach - Back Course	24
INTERCEPT CHARACTERISTICS.....	26
LOCALIZER AND/OR GLIDESLOPE COUPLER	28
ILS Approach Procedures	30
Limited Warranty Century Flight Systems Autopilot	32

COMMAND CONSOLE

The Century III console is designed to provide convenient fingertip command of all basic autopilot functions. Magnetic engage and mode switches are designed with logical interlocking features for operational ease and simplicity. The lucite face panel incorporates optically engineered night lighting with provisions for dimming control through the standard aircraft rheostat.

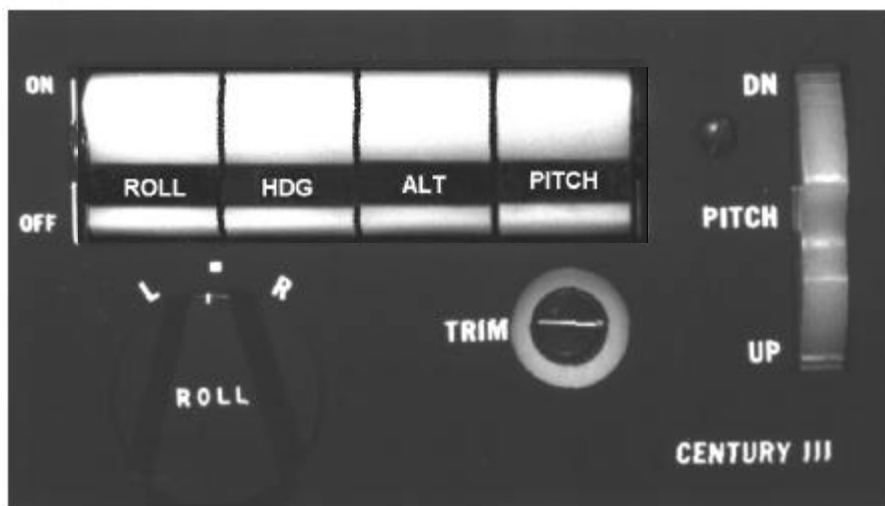

FIG. 1

ROLL (AILERON) ENGAGEMENT



FIG. 2

The Century III is separated into two distinct systems, the Roll/Heading and Pitch/Altitude. Each is engaged separately by means of a fail safe electronic servo engage mechanism.

Because the roll is first in logical sequence, the roll engage acts as an autopilot master switch. In this capacity the roll must be engaged for all other engage and mode switches to become operative. With this roll switch only engaged, the autopilot is responsive only to the roll axis of the attitude gyro and the commands of the console roll/turn control.

ROLL COMMAND KNOB



FIG. 3

The roll command knob controls the roll axis of the aircraft when roll mode switch is engaged. It is useful in maneuvering and will permit steeper bank angles (up to 30°) than those resulting from D.G. heading commands. When the heading mode switch is engaged the roll knob is removed from the autopilot circuit and is ineffective. However, it should be left in the centered position for convenience.

NOTE: Do not use roll mode during approach configuration on twin engine aircraft as engine failure will result in excessive heading deviation.

HEADING MODE

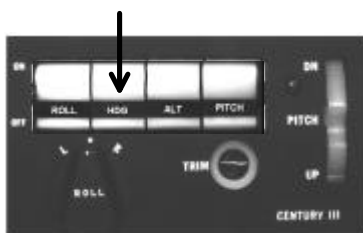

FIG. 4

The heading mode switch is located directly adjacent and to the right of the roll engage switch. It is the function of the heading mode switch to remove the roll command knob from the autopilot circuit and add the D.G., heading command and coupler functions to the basic roll attitude control. This switch is interlocked with the roll engage so that the roll function will be engaged simultaneously with the heading mode switch. Prior to engagement of the heading mode, the D.G. course selector and coupler modes should be set. (See sections on coupler operation when optional coupler is installed.)

COURSE SELECTOR D.G.



FIG 5

The course selector D.G. replaces the standard directional gyro and provides a fully visible course indicator around the normal D.G. opening. The D.G. dial is marked in 5° intervals and numbered each 30° around its azimuth. A center indice is provided at the top to align selected headings. Additional indices are located each 45° to facilitate rapid turn selection without mental arithmetic. Any heading may be selected, either before or after engagement, and turns up to 180° may be programmed directly, either right or left. If the course indicator is rotated beyond 180° from the D.G. card heading, the course selector will command a reversal in bank to reach the resultant selected heading in the shortest direction.

The D.G. card is normally set to the magnetic compass with the caging knob on the left in the usual fashion, while the course selector indicator is rotated by the heading knob on the right. Direction of rotation of both the knob and indicator commands the same direction of turn.

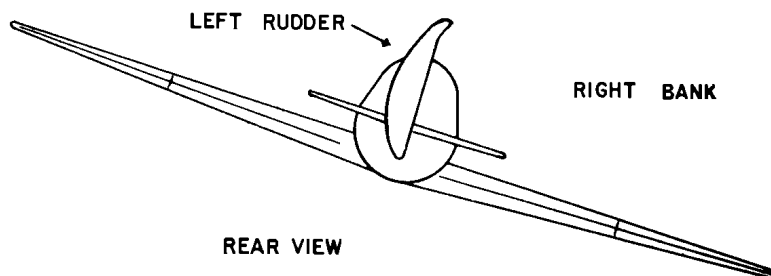

FIG. 6

AIRCRAFT TRIM EFFECTS

An important axiom to remember is that if the airplane is properly *trimmed*, a CENTURY FLIGHT SYSTEM INC. autopilot in heading mode will never fly the airplane with a wing down.

This statement can be changed slightly to apply to an airplane without an auto pilot: In order to fly a *trimmed* airplane on a constant heading, the wings must be held level.

Consider the effect of rudder trim in the above drawing (Fig. 6). Viewing the airplane from the rear, note that with left rudder applied the right wing must be lowered to offset the rudder effect and keep the heading constant, i.e. the left turn effect of the rudder is canceled by the right turn effect of the bank.

Since the Century III is slaved to heading, this is exactly what it will do in order to hold a heading when the rudder is out of trim.

Thus when operating on autopilot heading mode the pilot knows rudder trim in the direction toward the low wing is required.

TRIM INDICATOR AND PITCH COMMAND WHEEL

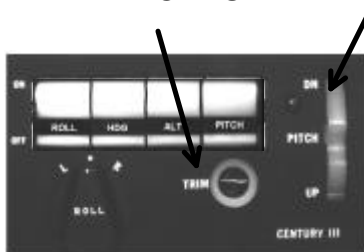

FIG. 7

Prior to the engagement of the pitch axis, it is desirable to adjust the autopilot pitch to match the attitude being flown in, this way the pilot can transition from hand flight to autopilot smoothly during the climbout or other pitch maneuvering. The pitch servo effort meter (trim) to the left of the pitch control wheel indicates the position of the pitch command wheel with relation to the attitude being flown.

Thus, if it is pointing upward prior to engagement it indicates that the aircraft can be expected to increase pitch attitude upon engagement, conversely a down meter indicates pitch attitude will be decreased upon engagement. The pitch command wheel is in the autopilot circuit when the pitch mode switch only is engaged. It is removed from the circuit and becomes ineffective upon engagement of the altitude hold. During altitude hold operation it may be set to level or preprogrammed to produce climb or descent upon altitude hold disengagement.

PITCH (ELEVATOR) ENGAGEMENT

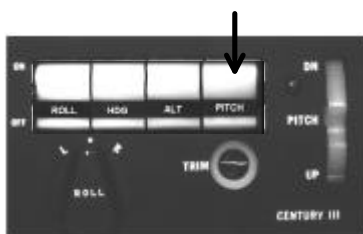

FIG. 8

The pitch mode switch engages the autopilot pitch servo and makes the autopilot responsive to the pitch attitude of the gyro horizon and the commands of the pitch control wheel. Constant attitudes may be directed by rotating the command wheel in the appropriate direction. The computer system in combination with the automatic trim will maintain this constant attitude through power changes and during gear and flap position transitions. On aircraft not equipped with Century Flight Systems, Inc. automatic trim, it will be necessary to disengage the pitch and manually trim the airplane during attitude, airspeed, or gear flap transitions. (See section on automatic trim.)

ALTITUDE HOLD

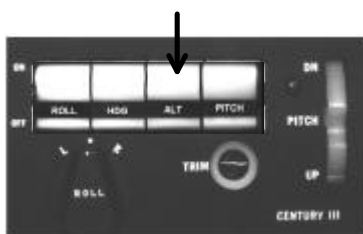

FIG. 9

The altitude hold is a "command" type which requires no pitch command adjustment prior to engagement. Engagement of the altitude mode switch will remove the pitch command wheel from the circuit and initiate a smooth transition to the pressure altitude at which it was engaged. Barometric sensors provide precise altitude holding with nominal climb and dive limitations for operation in turbulence.

AUTOMATIC TRIM OPERATIONS

Three different versions of CENTURY FLIGHT SYSTEM INC. Automatic Pitch Trim Systems are used with Century III Autopilots.

	AUTOPILOT PITCH ON	AUTOPILOT OFF
Normal	Automatic	Push Button
Dual Contact	Automatic	Push Button
Toggle	Automatic	Toggle Switch

The type used is based on the characteristics of the aircraft and FAA approval.

Trim operation with all three types is identical when the Autopilot Pitch is engaged. the Trim System operates on a full time basis and will automatically correct aircraft trim for airspeed changes that are called for by the Autopilot Pitch Command, Altitude Hold or power changes.

Push Button Automatic Trim operates when the autopilot is OFF. The pilot may press the wheel mounted push button any time he wishes to automatically relieve control forces. This will be particularly helpful during approaches when speed is being reduced and to make trim changes caused by lowering of flaps or gear.

Toggle Switch Trim operates when the autopilot is OFF. The pilot may press the wheel switch to cause electric trim action in the desired direction to relieve control wheel forces.

The pilot can override the trim system at any time by manual operation of the aircraft trim control. In addition, the circuit breaker switch labeled "Trim" on the instrument panel may be pulled to disconnect the trim from the aircraft electrical system.

GENERAL OPERATIONS

The Century III coupler and automatic trim systems are FAA approved on each make and model aircraft under a "Supplemental Type Certificate" (STC).

There are no restrictions to operations in turbulence and , as a general rule, autopilot operation in turbulence will result in lower "G" forces being imposed on the structure.

Autopilot and automatic trim operating airspeed limitations (if any) will be specified on the operation placard or in the flight manual supplement.

The Century III servo mechanisms are designed with a fail safe electric engage and disengage features. The autopilot may also be overridden by the pilot without damage to the system. Override forces are adjusted to the servo power output requirements of particular aircraft.

NOTE: Only CENTURY FLIGHT SYSTEM INC. trained specialists at approved service centers should adjust servo torque outputs.

PILOTS PREFLIGHT PROCEDURE

1. With engines running and gyros erected, check vacuum gage readings. Should be 4.75" to 5.00" Hg.
2. With all mode switches off, place coupler in HDG position (if applicable) and center roll and pitch commands and D.G. course selector indicator.
3. Engage roll mode master switch, rotate roll knob left and right and note that wheel responds in each direction.

NOTE: Without the aerodynamic response of flight continue to stop with command off center.

4. Engage "HDG" mode switch and rotate course selector indicator to either side, note roll servo response; again, without aerodynamic response, servo action is not limited.
5. While engaged, override the roll in both directions. Force required should be 10-15 lbs. at wheel edge dependent on aircraft model.
6. Center D.G. course selector so as to stop roll servo action while checking pitch.
7. Adjust pitch command knob so as to center "Trim" indicator.
8. Engage pitch mode switch and rotate pitch command knob in each direction. Observe pitch control action in each direction.

NOTE: Without the aerodynamic response of flight, pitch action is not limited in ground operation.

NOTE: If aircraft has heavy controls due to loading springs or bob weights, it may be necessary to assist the pitch control motion as servo input power may be limited to match inflight responses and override requirements.

NOTE: If autopilot ground check is prolonged, automatic trim may run to up or down limit. In such cases it may be desirable to temporarily pull the trim circuit breaker switch.

9. Check pitch override in each direction. Override forces will vary considerably with aircraft and direction of motion due to elevator spring and bob weight effect and the servo force adjustment.

TRIM CHECK**(Autopilot)**

10. The Automatic trim is activated by engagement of autopilot pitch mode switch. On systems equipped with CENTURY FLIGHT SYSTEMS INC. automatic pitch trim, note that trim action follows control force, (not motion) on ground check.

(Manual Push Button)

11. With all autopilot controls off, depress automatic trim butt on control wheel. Apply forward and aft load on control wheel and note that trim wheel or handle follows.

11a. (Manual Toggle Switch)

With all autopilot controls OFF, press Toggle Switch in both directions and note that Trim Wheel or handle runs in correct direction

NOTE: Aircraft equipped with dual contact trim system require a special pre-flight check-- consult airplane flight manual supplement or placards for these procedures.

NOTE: On aircraft equipped with springs and/or bob weights it may not be possible to apply a down loading on the elevator system.

12. Check pilot's trim control override in each direction.

13. Be sure all autopilot controls are off, that trim circuit breaker is reset, and that elevator trim is set prior to takeoff.

AUTOPILOT ENGAGE SEQUENCE (IN FLIGHT)

1. Trim aircraft to desired flight attitude.
2. Center roll knob and engage "Roll" mode switch.
3. Center D.G. course selector indicator and engage "HDG" mode switch.
4. Center "Trim" indicator with pitch command wheel and engage "Pitch" mode switch.
5. Engage "Alt" mode switch at desired altitude.

NOTE: When system is not equipped with CENTURY FLIGHT SYSTEM INC. automatic pitch trim, and manually adjust aircraft pitch trim for attitude and airspeed changes.

AIR FILTER

AIR FILTER AND ELEMENT

The 1X314 central air filter is incorporated on all 3" gyro systems with the exception of aircraft with original equipment filters of like quality.

The 1X314 filter system uses the 51A5 replaceable filter element which is capable of removing 97% of all contaminating substances above .3 microns. This includes tobacco tars that would otherwise be harmful to bearings and vanes. Because of this exceptional filtering ability, contaminants tend to accumulate at a higher rate than in other types. It is therefore considered necessary that filter elements be replaced at each 100 hour period and that filters subjected to tobacco tars, industrial smoke and like environment, be inspected each 50 hours for possible replacement.

Gyro warranty is dependent upon following this procedure.

LATERAL GUIDANCE SYSTEM

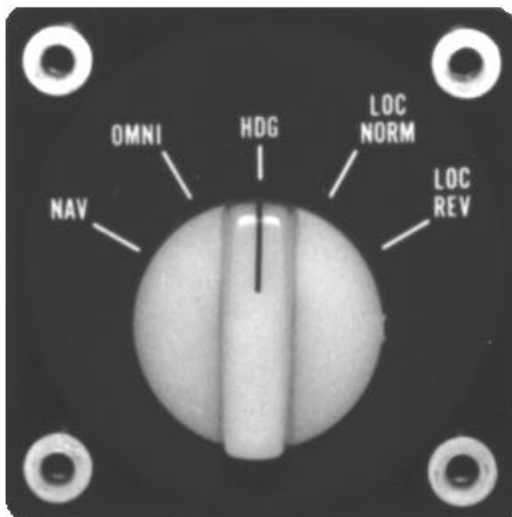

FIGURE 10

LATERAL GUIDANCE SYSTEM

The Century Flight Systems, Inc. Lateral Guidance System contains. Track interception angles a completely automatic, analog computer that directs the autopilot in both VOR and ILS navigation. The system contains a five position mode selector switch which mounts in the instrument panel are 45° and an automatic 15° crosswind correction capabilities is provided. The complete capture, intercept and tracking sequence is accomplished automatically without monitoring or multiple switching.



Figure 11

OMNI MODE

When in the OMNI MODE position, the system is coupled to the Radio Omni Bearing Indicator. By setting the D.G. Course Indicator to match the Omni Course selection, all headings are then controlled by the Omni radio signals. A full deflection on the Omni Indicator (10 or more off selected radial) will produce a 45° interception angle. Inside the 10° area, the system will automatically compute the location and closure rate to direct a smooth, tangential intercept without overshoot and arrive over the radial with crosswind correction established. The same dynamic intercept is accomplished whether 2 miles or maximum reception distance from station. Below 2 miles, the aircraft bank limitations will allow a slight overshoot when making maximum angle interception.



Figure 12

NAV MODE

The NAV Mode is designed to extend the coupler utility by making operation practical under the adverse conditions of unsteady or erratic VOR Signals. Several factors such as terrain, distance, bent courses, etc., produce short term needle deflections which can cause excessive roll motion when in the OMNI Mode. The NAV Mode incorporates an extended time delay in the computer circuit which reduces reaction to these short term needle deflections. Close in OMNI approach work requires the proportioned dynamic response as provided in the OMNI Mode. Therefore the NAV Mode should not be used for close in work.

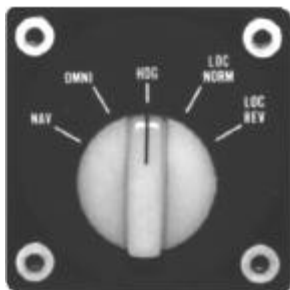

Figure 13

HEADING MODE

When in the HDG mode, the Century III Autopilot will function in the same manner as described in section I of this manual.



Figure 14

LOCALIZER (Normal) MODE

In the LOC NORM mode, the system automatically adjusts its sensitivity to accommodate the $2\frac{1}{2}^\circ$ full needle signal instead of the 10° as found in Omni navigation. As the Localizer beam which is only $\frac{1}{4}$ as wide as the Omni, additional damping circuits are also switched in to produce the same smooth intercept track as described for the Omni. Intercept angles of 45° are still automatic with full signal deflection and tangential intercepts with automatic crosswind correction are accomplished beyond the Outer Marker. As with the Omni mode, the Course Selection D.G. must be set to correspond with the desired magnetic track.



Figure 15

LOCALIZER (Reverse) MODE

All Century Flight Systems, Inc. Lateral Guidance Systems are equipped with the Localizer Reverse feature to permit automatic backcourse approaches and to track outbound on the Front Course prior to procedure turn. The features of LOC-NORM except that the aircraft will fly away from the Localizer Indicator needle instead of toward. When using the LOC-REV mode, the Course Selector D.G. is set to the reciprocal of the Front-Course heading.

LATERAL GUIDANCE SYSTEM OPERATION

- A. Establish aircraft in normal flight with autopilot as outlined in first part of manual.
- B. With Guidance Mode Selector in HDG position, engage the HDG Mode Switch on autopilot console.
- C. Lateral control is now directed by the "Lateral Guidance" Mode Selector.
- D. Set D.G, Card to the magnetic compass in normal manner.

NOTE: Some navigation receivers are designed in same package as the associated transmitter in such a manner that the visual navigation signal is temporarily interrupted when transmitting.

CAUTION: The NSD has an optional slaving feature that requires initial heading setting on start-up. Subsequent resetting of the heading card, required manually on non-slaved versions, is automatically accomplished with the slaved version.

Proper heading synchronization must be verified on other non-slaved and slaved NSD-360A units. This is accomplished by comparing the heading displayed under the lubber line with the magnetic compass.

The NSD-360A incorporates a heading warning flag to warn of loss of either air or electric power. Appearance of the flag during flight should be sufficient grounds to question the validity of the displayed heading. In slaved versions, the slaving meter should oscillate about a 45° point to show that the slaving meter are accomplishing their function. Should the needle remain motionless or either vertical or horizontal for an extended period (two minutes) in level flight, the heading should be manually set using the magnetic compass and the performance of the heading card observed. If this condition persists, set the slaving mode switch to SL#2 on free gyro. In free gyro mode, the instrument must be periodically reset to manually counteract the effects of gyro precession.

VOR NAVIGATION

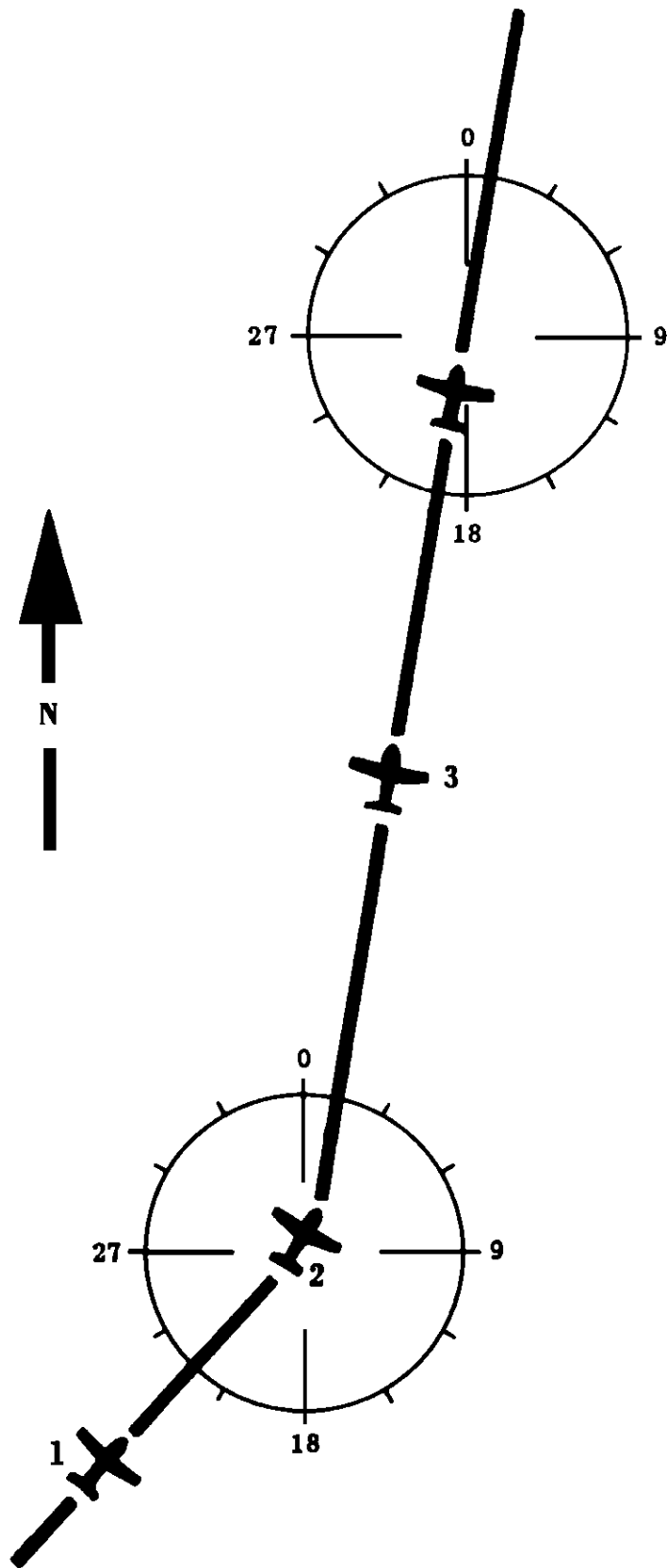

Figure 16

VOR NAVIGATION (See Fig. 16)

1. TO INTERCEPT

- A. Using Bearing Selector, dial desired course, inbound or outbound.
- B. Set identical heading on Course Selector D.G.
- C. After aircraft has stabilized, position coupler mode selector knob to OMNI mode.

NOTE: If less than 45° from selected radial, aircraft will intercept before station. If more than 45°, interception will occur after station passage.

- D. As aircraft nears selected radial, interception and crosswind will be automatically accomplished without further switching.
- E. As the aircraft nears the OMNI station, (½ mile) the zone of confusion will direct an “S” turn in alternate directions as the OMNI indicator needle swings. This alternate banking, limited to the standard D.G. bank angle, is an indication of station passage.

2. TO SELECT NEW COURSE

- A. To select any different outbound course or radial, including reciprocal of the previous inbound radial, dial the new course into the Course Selector D.G.
- B. Rotate OBS to the new course.
- C. Aircraft will automatically turn, in the shortest direction to the interception heading for the new course.

3. TO CHANGE STATIONS

- A. If same course is desired, merely tune receiver to new station frequency.
- B. If different course is desired, position coupler mode selector to HDG Mode.
- C. Dial Course Selector D.G. to new course.
- D. Dial OBS to new course.
- E. Position mode selector to OMNI mode.

VOR APPROACH

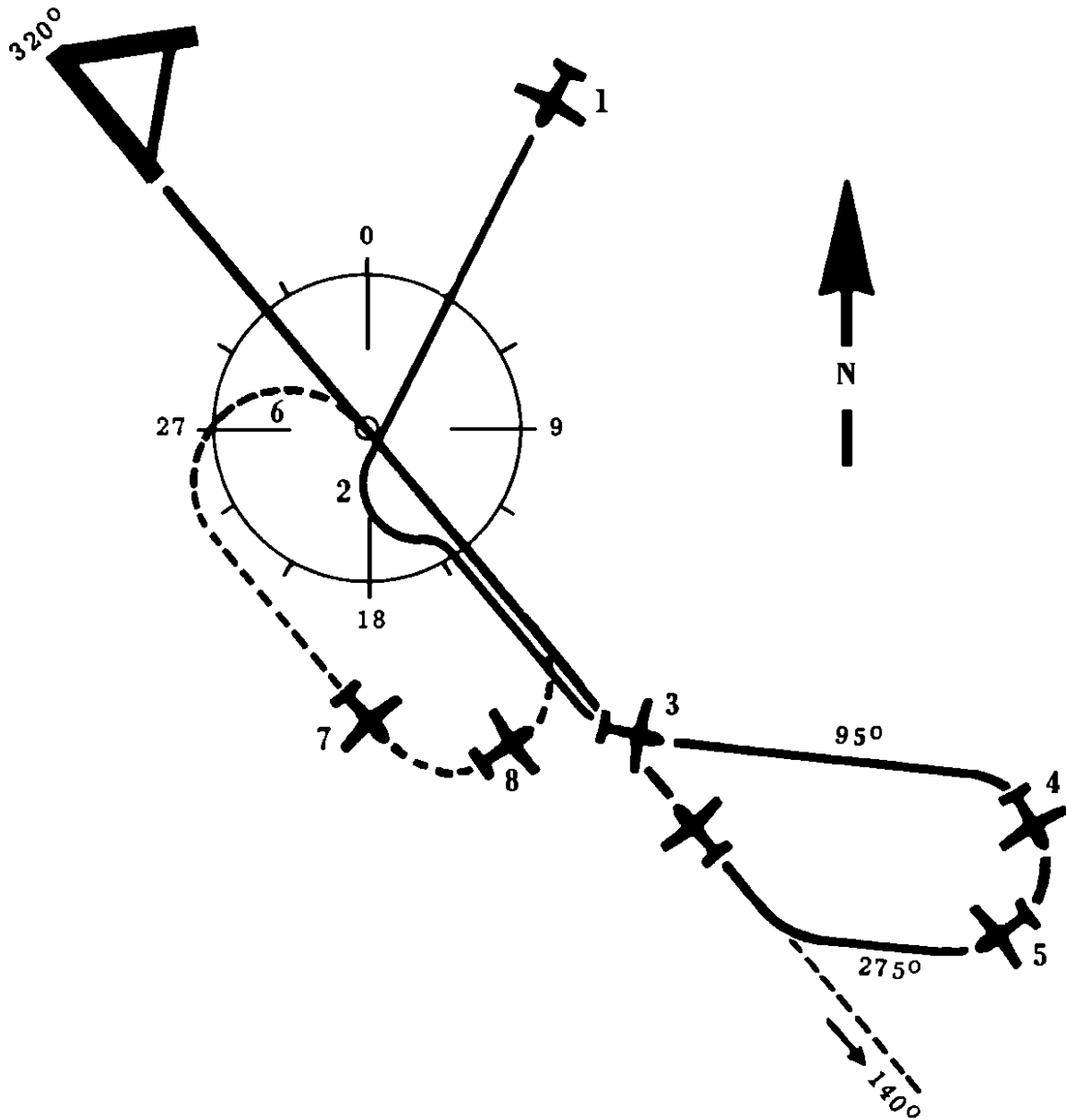

Figure 17

VOR APPROACH (See Fig.17)

1. Track inbound to station as described in VOR Navigation section.
2. After station passage (when “S” turn starts) dial outbound course on Course Selector in D.G. then dial same course on OBS.
3. After established on outbound radial, position mode selector to HDG mode and select outbound procedure turn heading.
4. After one minute, dial inbound procedure turn heading on Course Selector D.G. dialing toward desired turn. Set OBS to inbound course.
5. When 90° to inbound course, dial Course Selector D.G. to inbound course and position mode selector to OMNI mode.
6. If holding pattern is desired, position mode selector on HDG mode at station passage inbound and select outbound heading in direction of turn.
7. After elapsed time, dial inbound course on Course Selector D.G.
8. When 90° to radial, position mode selector on OMNI mode.

NOTE

NOTE: For precise tracking over Omni Station, without “S” turn, position mode selector on HDG. Until station passage.

ILS APPROACH—NORMAL

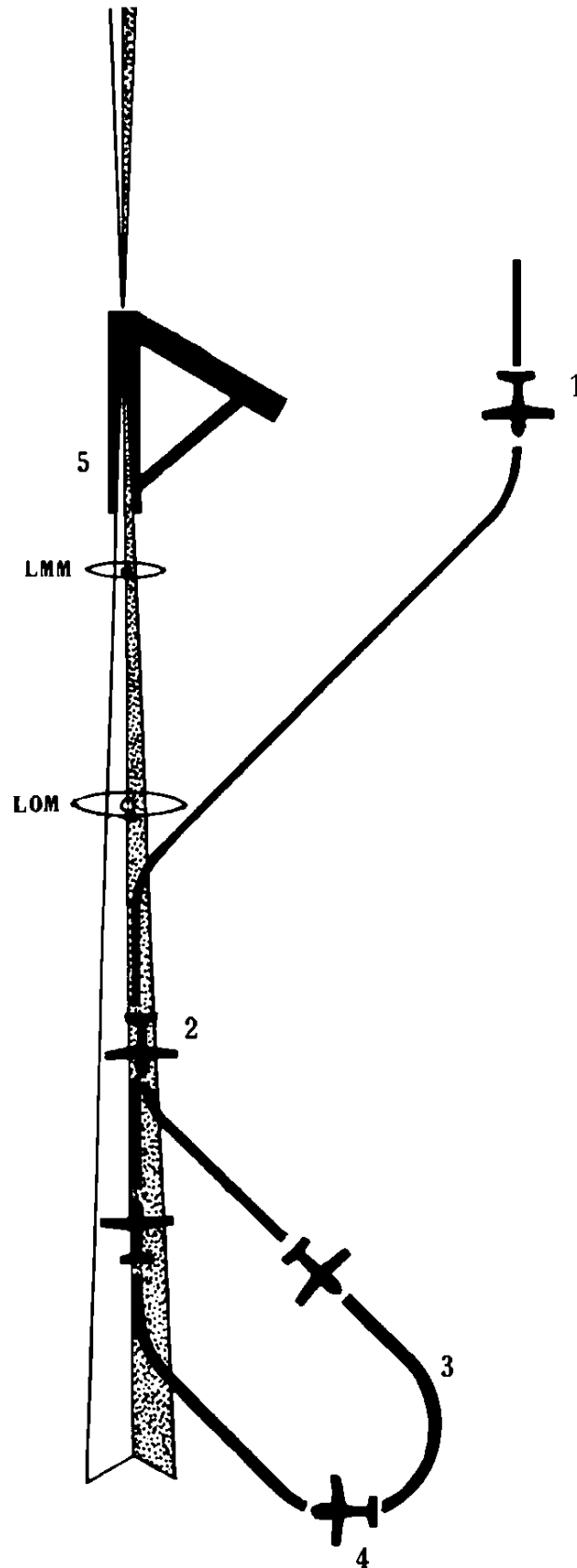

Figure 18

ILS APPROACH--NORMAL (See Fig. 18)

1. To Intercept
 - A. Dial ILS outbound on Course Selector D.G.
 - B. When stabilized; position mode selector to LOC REV mode.
2. After interception and when beyond outer marker, position mode selector to HDG and dial outbound procedure turn heading.
3. After one minute, dial inbound procedure turn heading in direction of turn.
4. When between 90° and 45° to ILS inbound course, dial inbound course on Course Selector D.G. and position mode selector to LOC NORM mode.
5. When beyond midpoint of runway, or when missed approach is elected, position mode selector to HDG mode and execute missed approach procedure.

ILS APPROACH--BACK COURSE

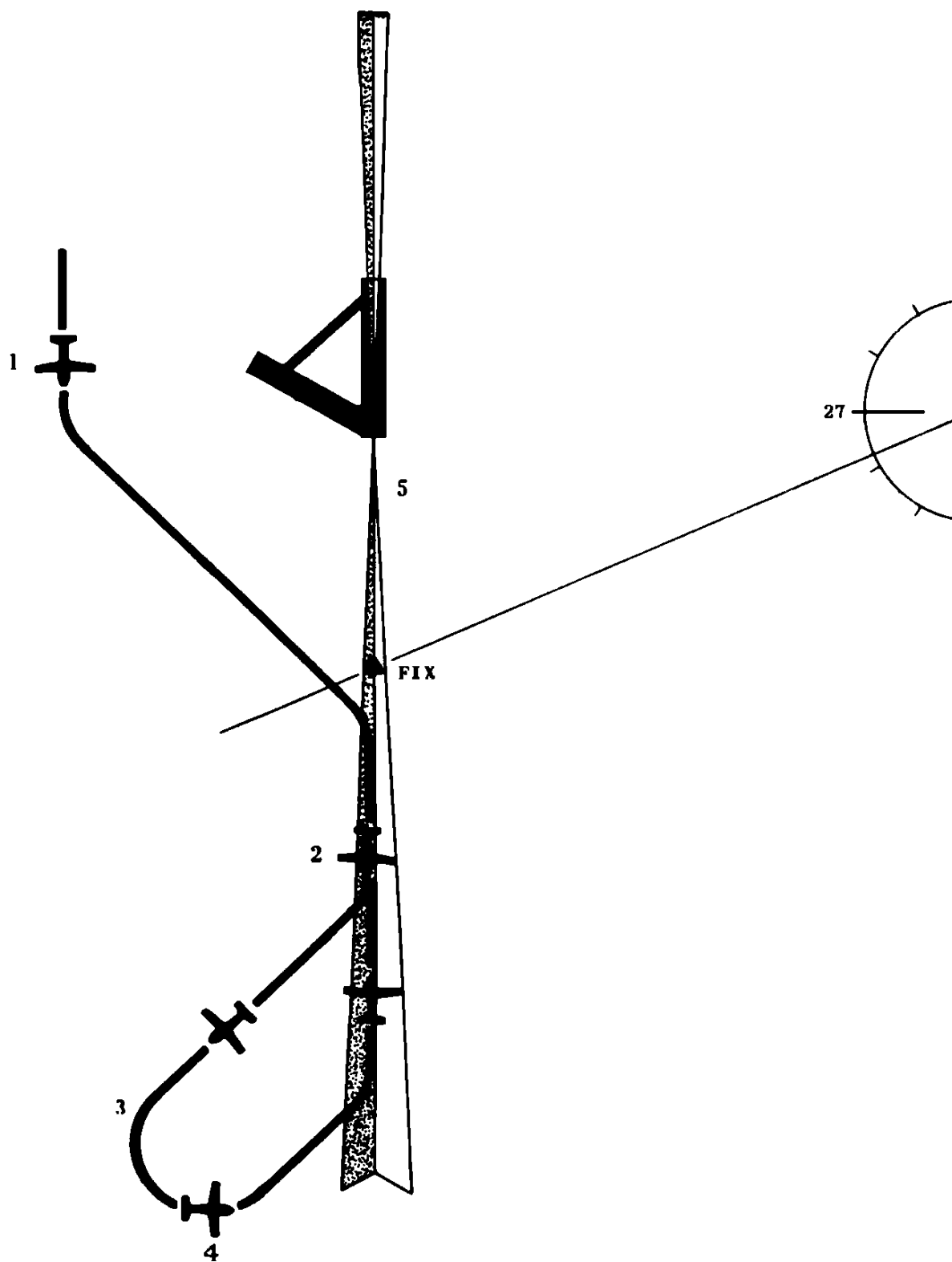

FIG. 19

ILS APPROACH--BACK COURSE (See Fig. 19)

1. To Intercept
 - A. Dial ILS Back Course outbound heading on Course Selector D.G.
 - B. When stabilized, position mode selector to LOC NORM mode.
2. After interception and when beyond fix, position mode selector to HDG and dial outbound procedure turn heading.
3. After one minute, dial inbound procedure turn heading indirection of turn.
4. When between 90° and 45° to inbound course, dial inbound course on Course Selector D.G. and position mode selector on LOC REV mode.
5. Approximately ½ mile away from runway, position mode selector to HDG mode to prevent "S" turn over ILS station near runway threshold.

INTERCEPT CHARACTERISTICS

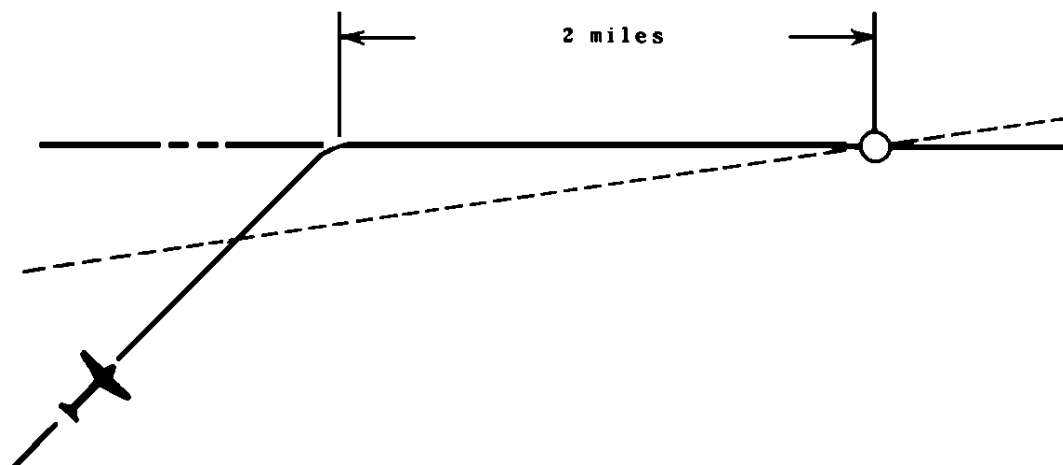

Figure 20

- (1) BEYOND 2 MILES FROM STATION: Aircraft approaches course at approximately 45° intercept angle until omni needle deflection is 50% of full scale, then turns to required heading (cross wind corrected for) with no overshoot of course.

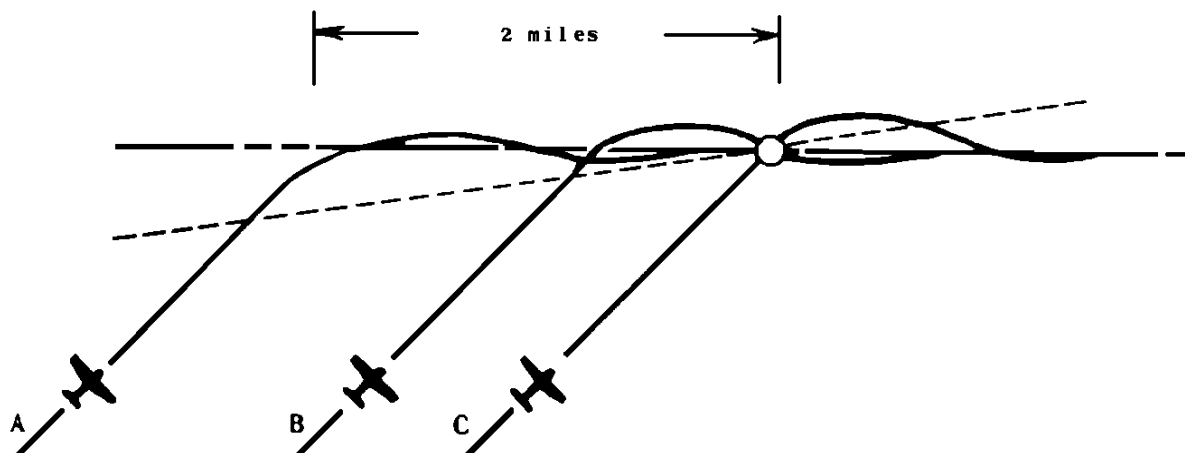

Figure 21

- (2) CLOSE IN INTERCEPT: With a given intercept angle established the time required to pass through the active region near the desired radial (-50% full needle deflection) is proportional to the distance from the station. For this reason overshoot occurs when close in intercepts are made. (This is true of all systems, since the turning rate or bank angle must be limited). The three paths show what might be expected as the intercept distance is made nearer and then finally at the station. It will be noted that if the intercept heading takes the aircraft very near to the station, no maneuvering would occur until the aircraft has passed the station.

- (3) INTERCEPT BEYOND THE STATION: Behavior beyond the station is similar to that explained in paragraph 2 in that as the intercept distance is made larger the tendency for overshoot is reduced.

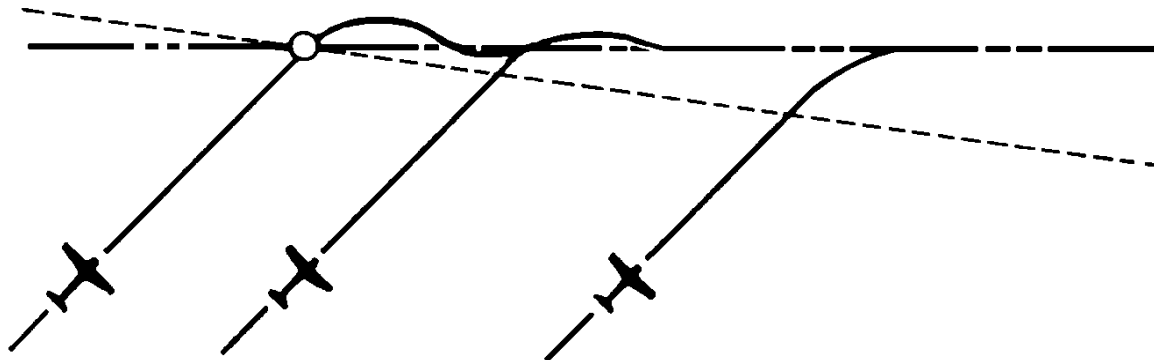

Figure 22

- (4) CROSS WIND EFFECTS: Crosswind effects which might be expected are illustrated in the three plots below. curve A is the no wind condition and performance will be as per sections (1) thru (3). Curve B shows the effect of approaching the desired course. Because this rate is reduced by the wind, the tendency to overshoot is likewise reduced. Curve C shows the effect of a wind which tends to increase the rate at which the aircraft approaches the course. As would be expected, this will tend to cause an overshoot.

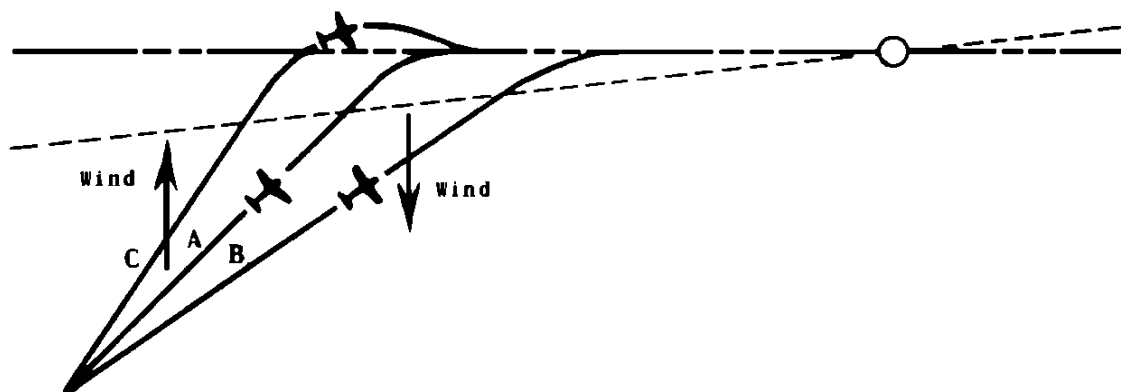

Figure 23

LOCALIZER AND/OR GLIDESLOPE COUPLER OPERATING INSTRUCTIONS

SYSTEM DESCRIPTION

The Century Flight Systems, Inc. Glideslope Coupler is a completely automatic analog computer that directs the Autopilot to intercept and track the approach glide path. The system automatically provides for variances in glide path angle, wind direction and various approach configurations of the aircraft. A self contained Logic Circuit provides for certain necessary conditions to be prevalent before automatic Glideslope coupling will occur. These conditions are explained in the following sections.



Figure 24

LOCALIZER (Normal) MODE

The Radio Coupler Mode Selector must be in the LOC NORM mode for at least 20 seconds before the Logic Circuit of the Glideslope Coupler is armed. This provides safety against inadvertent coupling when flying reverse course or tracking outbound on the front course. After coupling, the Glideslope may be de-coupled by the momentary switching of the mode selector from LOC-NORM position.

NOTE: In order to use Localizer as a navigation aid where glideslope coupling is not desired, do not use the LOC NORM mode. The Lateral Guidance System will fly the Localizer beam in the OMNI mode once your position on the beam is established.

ALTITUDE MODE



FIG 25

The Altitude switch must also be depressed in the ALT position at least 20 seconds before the logic circuit of the Glideslope Coupler is armed. This condition provides for Glideslope Coupling from all normal procedures but prevents attempting coupling from a high rate descent. After coupling, the Glideslope may be de-coupled by momentarily switching "OFF" the ALT button.

GLIDESLOPE DEVIATION INDICATOR

The Glideslope Deviation Indicator must be deflected upward for at least 20 seconds before the logic circuit of the Glideslope Coupler is armed. This provides assurance that the Glide path will be intercepted from below in the normal manner and prevents inadvertent coupling from above. A 60% full scale deflection for 20 seconds will always accomplish arming.

NOTE: Once coupled, the deviations Indicator will not de-couple the Glide regardless of needle deflection. The Deviation Indicator however must be monitored during approach to determine the aircraft's true position relative to the localizer beam and the glide path.

INDICATOR LIGHT

The Glideslope Coupler incorporates a panel mounted green indicator light. This light will turn ON at the same time automatic switching takes place to couple the Autopilot to the glide path. This light will stay lit until such time as the unit is de-coupled. As this light *only* shows that the Glideslope Coupler is switched into the Autopilot and not actual position relative to glide path. The deviation indicator must be monitored during the approach.

ILS APPROACH PROCEDURES GLIDESLOPE APPROACH (Typical)

1. To intercept ILS
 - a) Dial ILS outbound course on course selector D.G.
 - b) Position Radio Coupler mode switch to LOC REV mode.
 - c) Altitude Hold or Pitch Mode, for Altitude Control.
2. After intercept and at appropriate time, descent to approach altitude.
3. Press ALT Hold switch on console at published approach altitude. Dial procedure turn outbound heading on D.G. and position mode selector to HDG.
4. After one minute, dial the published in bound procedure turn heading moving D.G. course selector in direction of turn. When between 90 and 45 degrees to the inbound heading, dial inbound course on Course Selector D.G. and position mode selector to LOC NORM mode. NOTE: For optimum results, switch to localizer normal at 45°. At this point the airplane will automatically intercept and track the localizer beam, you should be at the proper altitude and on ALT Hold and the glideslope deviation needle should be up. If the above conditions are met for 20 seconds or more, the Glideslope Coupler logic circuit will be armed. Adjust power for the gear down or normal approach speed.
5. Upon interception of glide path (when deviation needle drops to center) the Glideslope Coupler will automatically engage the indicator light will come on, and the aircraft will assure a preset nose-down attitude for descent. Drop gear and re-adjust power as necessary to maintain approach speed. Position flaps not to exceed 15° for approach at this time . Do not change gear or flap setting after initial glideslope intercept for remainder of glideslope coupler operation. Power and airspeed changes must be made carefully to prevent excessive attitude changes.

NOTE: Monitor deviation indicators for actual position on Localizer and glide path. Transmissions may cause deviation needle to fluctuate on some radio installations. On such installations, the coupler will attempt to follow these deviations.

- A) Upon completion of Glideslope Coupler approach, or when VFR, disconnect Autopilot and adjust aircraft for landing configuration.
- B) For missed approach procedure, set Pitch Command to Climb Attitude. Switch Coupler to HDG mode and apply climb power, gear and flap up, disengage Altitude Hold and set Autopilot to missed approach HDG.

6. To de-couple any one of the following methods may be used:
 - A) Switch ALT Hold OFF. this will de-couple Glideslope and revert pitch control to the "Pitch Command Knob," which may be preset to desired climb attitude.
 - B) Switch ALT Hold OFF. then ON. this will de-couple Glideslope and return to altitude hold.
 - C) Switch Radio Coupler OFF, LOC-Norm mode. this will de-couple Glideslope and return pitch control to ALT Hold.
 - D) Disconnect entire autopilot and hand fly aircraft.

CAUTION:

Do not fly airplane on Autopilot below height above ground specified on placard (or flight manual supplement) for “ALT” loss, approach configuration, with 1 second delay recovery.”

Emergency Operation

1. In the event of a malfunction in the ROLL or PITCH SECTION, push the ROLL ON/OFF button “OFF.” This disengages both ROLL and PITCH SECTIONS of the Century III from the control system.
2. The PITCH TRIM SECTION may be overpowered manually. In the event of a malfunction in the PITCH-TRIM SECTION, pull the Pitch Trim circuit breaker.
3. The Century III ROLL SECTION may be overpowered manually on either control wheel. The Century III PITCH SECTION may be overpowered manually on either control wheel.
4. Engine Failure (Multi-Engine Airplanes)
 - a) When on ROLL and PITCH mode only, any one of the following applies during engine failure.
 1. Disengage Autopilot and trim aircraft.
 2. Level wings with roll knob, and handle emergency.
 3. Switch to HDG mode, (Course Selected) see (b).
 - b) Autopilot on HDG or coupled: Autopilot will compensate for yaw caused by engine power loss by banking toward the operating engine. Perform normal Engine Out Emergency Procedures and re-trim aircraft.

CAUTION

When electrical power is first applied to the NSD-360A instrument, the compass card may rotate or “slew” rapidly. This is NOT an indication that the compass system is orienting itself to the proper magnetic heading. The proper heading orientation must be verified and set prior to takeoff and should be verified prior to approach to landing using the magnetic compass.

Effective: July 4, 1975

LIMITED WARRANTY CENTURY FLIGHT SYSTEMS, INC. AUTOPILOT

Each new Century Flight Systems, Inc. Autopilot is warranted by the manufacturer to be free from defects in material and workmanship under normal use, subject to the following conditions:

1. Century Flight Systems, Inc. will through its designated service facilities at its option either repair or replace new components which shall within (12 months after date of installation, be found to Century Flight Systems, Inc. satisfaction, to have been defective in material or workmanship under normal use.
2. The warranty registration must be signed and returned to Century Flight Systems, Inc. within ten days of equipment installation date. In the event that the registration card is not returned within this time, the date of shipment from the factory will be deemed to be the installation date.
3. This warranty will not apply to any product which has been installed, repaired, or altered in any way whatsoever in Century Flight Systems, Inc. opinion to adversely affect its performance or reliability, or which has been subject to mis-use, contamination, negligence, or accident.
4. Cost of transportation, removal, or reinstallation are at the option of Century Flight Systems, Inc.
5. This is Century Flight Systems, Inc. sole express warranty with respect to the goods supplied herein. CENTURY FLIGHT SYSTEMS, INC. MAKES NO OTHER EXPRESS WARRANTY OF ANY KIND WHATSOEVER. CENTURY FLIGHT SYSTEMS, INC. EMPLOYEES MAY HAVE MADE ORAL STATEMENTS ABOUT THE PRODUCTS DESCRIBED IN THIS CONTRACT. SUCH STATEMENTS DO NOT CONSTITUTE WARRANTIES, SHALL NOT BE RELIED UPON BY THE CUSTOMER, AND ARE NOT PART OF THE SALE CONTRACT.
6. THE DURATION OF ANY IMPLIED WARRANTY, AND OF ALL WARRANTIES OF MERCHANTABILITY AND FITNESS FOR A PARTICULAR PURPOSE, SHALL BE LIMITED TO (12) MONTHS COMMENCING AT DATE OF INSTALLATION TO THE FULL EXTENT PERMITTED BY APPLICABLE LAW, CONSEQUENTIAL DAMAGE OR BREACH OF ANY WARRANTY ARE HEREBY DISCLAIMED AND EXCLUDED BY CENTURY FLIGHT SYSTEMS, INC.

Century Flight Systems, Inc.
P.O. Box 610
Municipal Airport
Mineral Wells, Texas
76067
August 1983

NOTES

NOTES