

**TSIO-360-A, B, C, D, E, F, H
TSIO-360-AB, BB, CB, DB, EB, FB,
GB, HB, JB, KB AND
LTSIO-360-E, EB, & KB**

CONTINENTAL® AIRCRAFT ENGINE

**OPERATOR'S
MANUAL**



Continental Motors, Inc.

FAA APPROVED

Supersedure Notice

This manual revision replaces the front cover and list of effective pages for Publication Part No. X30583, dated July 1985. Previous editions are obsolete upon release of this manual.

Effective Changes for this Manual

0..... July 1985			
1..... 31 August 2011			

List of Effective Pages

Document Title:TSIO-360 Series Engine Operator's Manual

Publication Number: X30583

Initial Publication Date: July 1985

Page	Change	Page	Change	Page	Change	Page	Change
Cover	1						
A.....	1						
i	1						
ii thru vi.....	0						
1-1 thru 1-2	0						
2-1 thru 2-4	0						
3-1 thru 3-12	0						
4-1 thru 4-6	0						
5-1 thru 5-62	0						
6-1 thru 6-8	0						
7-1 thru 7-12	0						
8-1 thru 8-8	0						
9-1 thru 9-10	0						
10-1 thru 10-8	0						
11-1 thru 11-6	0						

Published and printed in the U.S.A. by Continental Motors, Inc.

Available exclusively from the publisher: P.O. Box 90, Mobile, AL 36601.

Copyright © 2011 Continental Motors, Inc. All rights reserved. This material may not be reprinted, republished, broadcast, or otherwise altered without the publisher's written permission. This manual is provided without express, statutory, or implied warranties. The publisher will not be held liable for any damages caused by or alleged to be caused by use, misuse, abuse, or misinterpretation of the contents. Content is subject to change without notice. Other products and companies mentioned herein may be trademarks of the respective owners.

NOTICE

IN ORDER TO PROPERLY USE THIS ENGINE, THE USER MUST COMPLY WITH ALL INSTRUCTIONS CONTAINED HEREIN. FAILURE TO SO COMPLY WILL BE DEEMED MISUSE, RELIEVING THE ENGINE MANUFACTURER OF ANY RESPONSIBILITY.

THIS MANUAL CONTAINS NO WARRANTIES, EITHER EXPRESS OR IMPLIED. THE INFORMATION AND PROCEDURES CONTAINED HEREIN PROVIDE THE OPERATOR WITH TECHNICAL INFORMATION AND INSTRUCTIONS APPLICABLE TO SAFE OPERATION.

Continental Motors engine operating instructions are generated prior to and independently of the aircraft operating instructions established by the airframe manufacturer. Continental Motors engine operating instructions are developed using factory controlled parameters that are not necessarily the same as those specifications required to satisfy a specific aircraft I engine installation. Because of this difference the aircraft operator should use the airframe manufacturer's operating instructions found in the Pilots Operating Handbook (POH) while operating the aircraft unless otherwise specified by the original airframe manufacturer.

TABLE OF CONTENTS

	Page
INTRODUCTION	vi
SECTION	
I Design Features	1-1
II Specifications and Limits	2-1
III Normal Operating Procedures	3-1
IV In-Flight Emergency Procedures	4-1
V Engine Performance and Cruise Control	5-1
VI Abnormal Environmental Conditions	6-1
VII Engine Description	7-1
VIII Servicing and Inspection	8-1
IX Troubleshooting	9-1
X Storage and Removal From Storage	10-1
XI Glossary	11-1

LIST OF ILLUSTRATIONS

FIG.		PAGE
1	Sea Level Performance Curves, TSIO-360-A, AB, B, BB	5-3
2	Altitude Performance Curves, TSIO-360-A, AB, B, BB	5-4
3	Fuel Flow Vs. BHP, TSIO-360-A, AB, B, BB	5-5
4	Sea Level Performance Curves, TSIO-360-C, CB	5-6
5	Altitude Performance Curves, TSIO-360-C, CB	5-7
6	Fuel Flow Vs. BHP, TSIO-360-C, CB	5-8
7	Sea Level Performance Curves, TSIO-360-D, DB	5-9
8	Altitude Performance Curves, TSIO-360-D, DB	5-10
9	Fuel Flow Vs. BHP, TSIO-360-D, DB	5-11
10	Sea Level Performance Curves, L/TSIO-360-E, EB	5-12
11	Altitude Performance Curves, L/TSIO-360-E, EB	5-13
12	Fuel Flow Vs. BHP, L/TSIO-360-E, EB	5-14
13	Fuel Pump Inlet Press. Vs. % BHP, 110°F Avgas, L TSIO-360-E, EB	5-15
14	Sea Level Performance Curves, TSIO-360-F, FB	5-16
15	Altitude Performance Curves, TSIO-360-F, FB	5-17
16	Fuel Flow Vs. BHP, TSIO-360-F, FB	5-18
17	Sea Level Performance Curves, TSIO-360-GB	5-19
18	Altitude Performance, 2700 RPM, TSIO-360-GB	5-20
19	Altitude Performance, 2600 RPM, TSIO-360-GB	5-21
20	Altitude Performance, 2500 RPM, TSIO-360-GB	5-22
21	Altitude Performance, 2400 RPM, TSIO-360-GB	5-23
22	Altitude Performance, 2200 RPM, TSIO-360-GB	5-24
23	Altitude Performance, 2000 RPM, TSIO-360-GB	5-25
24	Altitude Performance, 1800 RPM, TSIO-360-GB	5-26
25	Power Management Operating Recommendations, TSIO-360-GB	5-27
26	Fuel Flow Vs. BHP, TSIO-360-GB	5-28
27	Critical Altitude Vs. Engine Speed (Standard Day), TSIO-360-GB	5-29
28	Sea Level Performance Curves, TSIO-360-H, HB	5-30
29	Sea Level Performance to Altitude, TSIO-360-H, HB	5-31
30	Altitude Performance, 2800 RPM, TSIO-360-H, HB	5-32
31	Altitude Performance, 2700 RPM, TSIO-360-H, HB	5-32
32	Altitude Performance, 2600 RPM, TSIO-360-H, HB	5-33
33	Altitude Performance, 2500 RPM, TSIO-360-H, HB	5-33
34	Altitude Performance, 2400 RPM, TSIO-360-H, HB	5-34
35	Altitude Performance, 2300 RPM, TSIO-360-H, HB	5-34
36	Altitude Performance, 2200 RPM, TSIO-360-H, HB	5-35
37	Fuel Flow Vs. BHP, TSIO-360-H, HB	5-36

LIST OF ILLUSTRATIONS

FIG.		PAGE
38	Sea Level Performance Curves, TSIO-360-JB	5-37
39	Sea Level Performance to Altitude, TSIO-360-JB	5-38
40	Altitude Performance, 2800 RPM, TSIO-360-JB	5-39
41	Altitude Performance, 2700 RPM, TSIO-360-JB	5-39
42	Altitude Performance, 2600 RPM, TSIO-360-JB	5-40
43	Altitude Performance, 2500 RPM, TSIO-360-JB	5-40
44	Altitude Performance, 2400 RPM, TSIO-360-JB	5-41
45	Altitude Performance, 2300 RPM, TSIO-360-JB	5-41
46	Altitude Performance, 2200 RPM, TSIO-360-JB	5-42
47	Fuel Flow Vs. BHP, TSIO-360-JB	5-43
48	Sea Level Performance Curves, L/TSIO-360-KB	5-44
49	Altitude Performance, 2800 RPM, L/TSIO-360-KB	5-45
50	Altitude Performance, 2700 RPM, L/TSIO-360-KB	5-46
51	Altitude Performance, 2600 RPM, L/TSIO-360-KB	5-47
52	Altitude Performance, 2500 RPM, L/TSIO-360-KB	5-48
53	Altitude Performance, 2400 RPM, L/TSIO-360-KB	5-49
54	Altitude Performance, 2300 RPM, L/TSIO-360-KB	5-50
55	Altitude Performance, 2200 RPM, L/TSIO-360-KB	5-51
56	Power Management Operating Recommendations, L/TSIO-360-KB	5-52
57	Fuel Flow Vs. BHP, L/TSIO-360-KB	5-53
58	Critical Altitude Vs. Engine Speed (Standard Day), L/TSIO-360-KB	5-54
59	Metered Fuel Press. Vs. Fuel Flow, All Models	5-55
60	Fuel Pump Inlet Press. Vs. % BHP, 110°F Avgas, TSIO-360-F, FB, GB, KB	5-56
61	Vapor Return Flow Vs. Pump Pressure, TSIO-360-F, FB, GB, KB	5-57
62	Fuel Flow Vs. Pressure Drop, TSIO-360-GB, KB	5-58
63	Speed Correction Chart - S L to 2000 Ft. MSI., TSIO-360-F, FB, GB, KB	5-59
64	Critical Altitude Variations. (Typical) Simple Turbo Systems, TSIO-360-F, FB, GB, KB	5-60
65	Typical Engine Fuel System Operating Characteristics - 2600 RPM (Standard Day at S/L)	5-61
66	Oil Lubrication Diagram	7-2
67	Fuel System Schematic	7-5
68	Induction/Exhaust System Schematic	7-7
69	Turbocharger Sectional	7-8
70	Fixed Orifice Wastegate, TSIO-360-E, EB, F, FB, GB, KB I TSIO-360-E, FB, KB	7-8
71	Ignition Wiring Diagram	7-10

INTRODUCTION

This booklet is intended to provide pilots, operators and maintenance personnel with recommended procedures relating to engine operation, servicing and periodic maintenance. Subjects are limited to engine operation and inspection normally carried out on engines installed in aircraft. No effort is made herein to describe extensive repair work or overhaul. For such instructions, refer to the applicable overhaul manual. Careful observation of operating limits and compliance with recommended inspection procedures herein will result in greater engine reliability.

The operating instructions outlined in this manual have been developed for general airframe installation; for a particular airframe refer to the appropriate aircraft operator's manual. Recommendations, cautions and warnings regarding operation of this engine are not intended to impose undue restrictions on operation of the aircraft, but are inserted to enable the pilot to obtain maximum performance from the engine commensurate with safety and efficiency. Abuse, misuse or neglect of any piece of equipment can cause eventual failure. In the case of an aircraft engine it should be obvious that a failure may have disastrous consequences. Failure to observe the instructions contained in this manual constitutes unauthorized operation in areas unexplored during development of the engine, or in areas in which experience has proved to be undesirable or detrimental.

Notes, Cautions and Warnings are included throughout this manual. Application is as follows:

NOTE: Special interest information which may facilitate the operation of equipment.

***CAUTION:** Information issued to emphasize certain instructions or to prevent possible damage to engine or accessories.*

WARNINGS: Information which, if disregarded, may result in severe damage or destruction of the engine or endangerment to personnel.

Users are advised to keep up with latest information by means of service bulletins, which are available for study at any approved Teledyne Continental Motors Distributor location, and are also available on an annual subscription basis. Subscription forms are available at Distributors or from Teledyne Continental Motors, P.O. Box 90, Mobile, Alabama 36601, Attention: Publications Department.

WARNING . . . This engine must be installed in accordance with all requirements and limitations listed in the Specifications and Limits for Teledyne Continental Aircraft Engines.

SECTION I

DESIGN FEATURES

The engines described herein are turbocharged, fuel injected, six-cylinder horizontally opposed, air cooled, and incorporate an overhead valve design. All provide a 360 cubic inch displacement, 4.44 inch bore, 3.87 inch stroke and 7.5 to 1 compression ratio. The turbocharger is driven by exhaust gases and engine models A, AB, B, BB, C, CB, D, DB, H, HB & JB incorporate a variable pressure controller, pressure relief valve and a wastegate assembly. The models E, EB, F, FB, GB & KB use a fixed orifice type bypass assembly. The turbine and compressor assembly is connected to the induction/exhaust system with hoses, linkage and ducting required for a functional installation and is lubricated by engine oil. Provisions are made for installation of variable pitched propeller and propeller governor assembly. The crankshaft flange has six bolt holes, two dowel pins and a center pilot extension provided for attaching the propeller. Provisions are made in the pilot extension for the hydraulic propeller control oil, which is supplied internally from the governor pad. The crankshaft is also equipped with pendulum type torsional damper weights. The engine has removable hydraulic tappets. Positive rotation is provided for the valves by the use of rotors. Tappets, pushrod ends, rocker arm bushings, valves, etc. are lubricated by the engine oil pressure system. The engine is equipped with a right angle drive starter adapter and a direct drive starter motor. The engine main fuel filter, engine controls, vacuum pump and propeller governor are furnished by the aircraft manufacturer.

The relatively high power delivered by these engines, per pound of weight, is achieved by utilization of carefully selected high strength materials, by improvements in design calculated to make the most of these high quality materials, and by very close control of critical dimensions, surface finishes, heat treatment and hardening processes. Careful work has produced rugged engines; however, no amount of ruggedness built into an engine will enable it to withstand serious mistreatment. Overheating, neglect, inferior fuels or lubricants will seriously affect engine performance, particularly since the specified power rating is high and each part must be free to function properly in order to withstand the imposed loads with

minimum wear. These considerations are mentioned in order to emphasize the necessity of using only the manufacturer's fuel and oil recommendations and of keeping the fuel, oil and air filters clean.

The increased diameter crankshaft versions of the TSIO-360 series (identified by a second letter "B" in the model, *i.e.*, TSIO-360-EB) have the same operating limitations as the standard models. The modified crankshaft engines may be used as replacement engine for the standard model, but the reverse is not certified. For example, a TSIO-360-EB may be installed to replace a TSIO-360-E, but a TSIO-360-E may not be installed to replace a TSIO-360-EB.

SECTION II

SPECIFICATIONS AND LIMITS

Specifications for the TSIO-360 Series Aircraft Engines:

FAA Type Certificate Number E9CE

RATINGS

Maximum Continuous BHP See Tabulated Data

Maximum Continuous RPM See Tabulated Data

Maximum Continuous Manifold

Pressure, In. HG. See Tabulated Data

CYLINDER DATA:

Number of Cylinders 6

Displacement (Cubic Inches) 360

Bore and Stroke (Inches) 4.44 x 3.88

Compression Ratio 7.5:1

PROPELLER DRIVE DATA:

Type ARP 502

Direction of rotation TSIO - clockwise

LTSIO - counterclockwise

Ratio (To Crankshaft) 1:1

Vibration Dampers, Number & Order

Models A, B Two 6th

Models AB, BB, C, CB, D, DB, E, EB,

F, FB, GB, H, HB, JB, KB One 6th, One 4½

FUEL SYSTEM:

Type Continuous Flow Fuel Injection

Make Teledyne Continental Motors

Fuel - (Min. Grade Aviation Gasoline

Conforming to ASTM-D410-46) 100 or 100LL

LUBRICATION SYSTEM:

Specification	MHS-24B
Grade (SAE)	
Above 40°F. Ambient Air (Sea Level)	SAE 50
Below 40°F. Ambient Air (Sea Level)	SAE 30 or 10W-30
Sump Capacity, Quarts Maximum	
Models E,EB,F,FB,GB,KB	8
Models A,AB,B,BB,C,CB,D,DB,H,HB,JB	10
Usable Oil Quarts Nose Up	6.1
Usable Oil Quarts Nose Down	6.1
(Refer to Overhaul Manual for model and degrees of angle)	

ACCESSORIES:

See appropriate parts catalog and specification list for accessories pertaining to your engine model.

TABULATED DATA AND LIMITS

	A,AB	B,BB	C,CB	D,DB	E,EB
Cylinder Bore (inch)	4.44	4.44	4.44	4.44	4.44
Piston Stroke (inch)	3.87	3.87	3.87	3.87	3.87
Total Displacement (cu. in.)	360	360	360	360	360
Compression Ratio	7.5:1	7.5:1	7.5:1	7.5:1	7.5:1
Rated Max. Cont. BHP	210	210	225	225	200
Rated Max. Cont. RPM	2800	2800	2800	2800	2575
Rated Max. Take-off BHP	210	210	225	225	200
Rated Max. Take-off RPM	2800	2800	2800	2800	2575
Max. Rec. Cruise BHP	157	157	146	146	150
Max. Rec. Cruise RPM	2600	2600	1800	1800	2450
Rec. Idling RPM	600	600	600	600	700
Max. Man. PR Cont.	32.0	32.5	37.0	36.0	40.0
Max. Man. PR Take-off	—	—	—	—	—
Min. Fuel Oct. Rating	100LL/100	100LL/100	100LL/100	100LL/100	100LL/100
Oil Press. Cruise psi	30-60	30-60	30-60	30-60	30-80
Oil Press. Idle psi (Min.)	10	10	10	10	10
Oil Press. Max. Allow. (Cold)	100	100	100	100	100
Min. Oil Temp. for T.O. °F.	75	75	75	75	75
Max. Allow. Oil Temp. °F.	240	240	240	240	240
Max. All Cyl. Head Temp. °F.	460	460	460	460	460
Max. Allow. Oil Cons. lbs/BHP/hr. ①	.015	.015	.015	.015	.015
Firing Order	1-6-3-2-5-4	1-6-3-2-5-4	1-6-3-2-5-4	1-6-3-2-5-4	1-6-3-2-5-4 ②
Ignition Timing ° BTC Both Magnetos	20	20	20	20	20
Basic Engine Weight (No accessories)	300.75	296.75	285.0	285.0	285.0
Total Engine Dry Weight					
with Accessories (Subject to					
Production Variation of ± 2.5%)	333.56	329.56	302.0	302.0	385.0

① Formula: $.006 \times \frac{\text{Power}}{100}$

② 1-4-5-2-3-6 for LTSIO-360 Series.

TABULATED DATA AND LIMITS

	F,FB	GB	H,HB	JB	KB
Cylinder Bore (inch)	4.44	4.44	4.44	4.44	4.44
Piston Stroke (inch)	3.87	3.87	3.87	3.87	3.87
Total Displacement (cu. in.)	360	360	360	360	360
Compression Ratio	7.5:1	7.5:1	7.5:1	7.5:1	7.5:1
Rated Max. Cont. BHP	200	210	210	225	220
Rated Max. Cont. RPM	2575	2700	2800	2800	2800
Rated Max. Take-off BHP	200	210	210	225	220
Rated Max. Take-off RPM	2575	2700	2800	2800	2800
Max. Rec. Cruise BHP	150	160	137	147	160
Max. Rec. Cruise RPM	2450	2450	2450	2450	2500
Rec. Idling RPM	700	700	600	600	700
Max. Man. PR Cont.	41.0	40.0	34.5	37.0	40.0
Max. Man. PR Take-off	—	—	—	—	—
Min. Fuel Oct. Rating	100LL/100	100LL/100	100LL/100	100LL/100	100LL/100
Oil Press. Cruise psi	30-80	30-80	30-60	30-60	30-80
Oil Press. Idle psi (Min.)	10	10	10	10	10
Oil Press. Max. Allow. (Cold)	100	100	100	100	100
Min. Oil Temp. for T.O. °F.	75	75	75	75	75
Max. Allow. Oil Temp. °F.	240	240	240	240	240
Max. All Cyl. Head Temp. °F.	460	460	460	460	460
Max. Allow. Oil Cons. lbs./BHP/hr. ①	.015	.015	.015	.015	.015
Firing Order	1-6-3-2-5-4	1-6-3-2-5-4	1-6-3-2-5-4	1-6-3-2-5-4	1-6-3-2-5-4 ②
Ignition Timing °BTC Both Magnetos	20	20	20	20	20
Basic Engine Weight (No accessories)	342.05	350.0	296.00	296.00	350.0
Total Engine Dry Weight					
with Accessories (Subject to Production Variation of ± 2.5%)	393.05	386.0	313.00	313.00	392.0

① Formula: $.006 \times \frac{\% \text{ Power}}{100}$

② 1-4-5-2-3-6 for LTSIO-360 Series.

SECTION III

NORMAL OPERATING PROCEDURE

CAUTION . . . This section pertains to flight operations conducted under "Standard Day" conditions. The pilot should thoroughly familiarize himself with the Section on Abnormal Operating Conditions. Whenever such abnormal conditions are encountered or anticipated, the procedures and techniques for normal operation should be tailored accordingly. For example, if the aircraft is to be temporarily operated in extreme cold or hot weather, consideration should be given to an early oil change and/or a routine inspection servicing.

GENERAL

The life of your engine is determined by the care it receives. Follow the instructions contained in this manual carefully.

The engine receives a run-in operation before leaving the factory. Therefore, no break-in schedule need be followed. Straight mineral oil (MIL-C-6529 Type II) should be used for the first oil change period (25 hours).

The minimum grade aviation fuel for these engines is 100LL (Blue) or 100 (Green). In case the grade required is not available, use a higher rating. Never use a lower rated fuel.

WARNING . . . The use of a lower octane rated fuel can cause pre-ignition or detonation, which can damage an engine the first time high power is applied. This will most likely occur on takeoff. If the aircraft is inadvertently serviced with the wrong grade of fuel, completely drain and properly service fuel tank/tanks.

NOTE . . . The following checklists are general in nature, since the various airframe/powerplant combinations are not necessarily the same in setup and layout. Consult your own pilot's operating handbook for the specific challenge and response checklists required for your aircraft.

PRESTARTING

Before each flight the engine and propeller must be examined for damage, oil leaks, security and proper servicing.

1. Place the ignition switch to the "OFF" position.
2. Operate all controls and check for binding and full range of travel.
3. Assure that fuel tanks contain proper grade and quantity of fuel. (100LL-Blue or 100-Green).
4. Drain a quantity of fuel from all sumps and strainers into a clean container. If water or foreign matter is noted, continue draining until only clean fuel appears.
5. Check oil level in sump.
6. Check cowling for security.

STARTING

1. Fuel Selector - ON, appropriate tank.
2. Propeller Control - HIGH RPM.
3. Mixture Control - FULL RICH.
4. Battery Switch - ON.
5. Throttle - FULL OPEN.
6. Boost Pumps or Primer - ON, 2 to 3 seconds.
7. Throttle - 1/2 INCH OPEN.
8. Magneto/Start Switch - START position.

Release the Magneto/Start Switch to BOTH position as soon as the engine starts.

CAUTION . . . Do not engage the starter when the engine is running as this will damage the starter. Do not crank for longer than thirty seconds at a time, as this may cause the starter motor to overheat. If the engine does not start after thirty seconds of cranking, allow a 3 to 5 minute cooling period before attempting to restart.

CAUTION . . . If engine kicks back when starting, DO NOT attempt to start. The ignition starting system is inoperative and must be repaired before damaging starter adapter assembly.

(Cold Starts)

- a. Throttle - FULL OPEN.
- b. Mixture Control - FULL RICH.
- c. Primer - ON, 2 to 3 seconds.
- d. Throttle - 1/2 INCH OPEN.
- e. Magneto/Start Switch - START position.
- f. Once engine starts, it may be necessary to keep engine running with primer.
- g. Magneto/Start Switch - BOTH position.

(Flooded Engine)

- a. Mixture Control - IDLE CUT-OFF.
- b. Throttle - FULL OPEN.
- c. Magneto/Start Switch - START.
- d. Once engine starts, release Magneto/Start Switch to BOTH. Retard the throttle to 1000 RPM and slowly advance the mixture control to FULL RICH position.

(Hot Starts)

- a. Throttle - FULL OPEN.
- b. Mixture Control - IDLE CUT-OFF.
- c. Boost Pump - ON, 10-15 seconds or until the fuel pumping pulsations stabilize.
- d. Mixture Control - FULL RICH, momentary priming may be required.
- e. Throttle - Retard to 1/2 INCH.
- f. Magneto/Start Switch - START position.
- g. Once engine starts, release Magneto/Start Switch to BOTH.

STARTING (Cont'd.)

9. Throttle 1000 to 1500 RPM.
10. Oil Pressure - ABOVE 30 POUNDS WITHIN 30 SECONDS.
11. Alternator Switch - ON.
12. Use the same procedure to start other engine, if operating a twin engine installation.

GROUND RUNNING: WARM-UP

Teledyne Continental aircraft engines are aircooled, and therefore dependent upon the forward speed of the aircraft for cooling. To prevent overheating, it is important that the following rules be observed.

1. Head the aircraft into the wind.
2. During ground operations the propeller should be in the "Full Increase" RPM position.

3. Avoid prolonged idling at low RPM. Fouled spark plugs can result from this practice.
4. Leave mixture in "Full Rich". (See "Ground Operation at High Altitude Airports," Section VI for exceptions).
5. Warm-up 900-1000 RPM.

PRE-TAKEOFF CHECK

1. Maintain engine speed at approximately 1000 to 1500 RPM for at least one minute in warm weather, and as required during cold weather to prevent cavitation in the oil pump and to assure adequate lubrication.
2. Advance throttle slowly until tachometer indicates an engine speed of 1200 RPM. Allow additional warm-up time at this speed depending upon ambient temperature. This time may be used for taxiing to take-off position. The minimum allowable oil temperature for run-up is 75°F.

CAUTION . . . Do not operate the engine at run-up speed unless oil temperature is 75°F. minimum.

3. Perform all ground operations with cowl flaps, if installed, full open, mixture control in "FULL RICH" and the propeller control set for "Full Increase" RPM (except for brief testing of propeller governor).
4. Restrict ground operations to the time necessary for warm-up and testing.
5. Increase engine speed to 2000 RPM only long enough to perform the following checks:
 - a. Magnetos: With both magnetos "ON", position the right magneto switch "OFF" and note engine RPM; now back to both magnetos "ON" to clear the spark plugs. Then position the left magneto switch "OFF" and note engine RPM. Now return switch to both magnetos "ON". The difference between the two

magnetos operated individually should not differ more than 50 RPM with a maximum drop for either magneto of 150 RPM. Observe engine for excessive roughness during this check.

If no drop in RPM is observed when operating on either magneto alone, the switch circuit should be inspected.

WARNING . . . Absence of RPM drop when checking magnetos may indicate a malfunction in the ignition circuit. This type of malfunction should be corrected prior to continued operation of the engine. Should the propeller be moved by hand (as during preflight) the engine may start and cause injury to personnel.

CAUTION . . . Do not underestimate the importance of a pre-takeoff magneto check. When operating on single ignition, some RPM drop should be noted. Normal indications should be a 25-75 RPM drop and slight engine roughness as each magneto is switched off. Absence of a magneto drop may be indicative of an open switch circuit or an improperly timed magneto. A drop in RPM that exceeds 150 may indicate a faulty magneto or fouled spark plugs.

b. Minor spark plug fouling can usually be cleared as follows:

- (1) Magnetos - Both On.
- (2) Throttle - 2200 RPM.
- (3) Mixture - Move toward idle cutoff until RPM peaks and hold for ten seconds. Return mixture to full rich.
- (4) Magnetos - Recheck (per paragraph 5a).

If the engine is not operating within specified limits, it should be inspected and repaired prior to continued operational service.

CAUTION . . . Avoid prolonged single magneto operation to preclude fouling of the spark plugs.

c. Check throttle and propeller operation.

(1) Move propeller governor control toward low RPM position and observe tachometer. Engine speed should decrease to minimum governing speed (200-300 RPM drop). Return propeller control to "Full Increase" RPM. Repeat this procedure two or three times to circulate warm oil into the propeller hub.

(2) In aircraft installed with full feathering propellers, move propeller to "feather" position. Observe for 300 RPM drop below minimum governing RPM, then return control to "full increase" RPM position.

CAUTION . . . Do not operated the engine at a speed in excess of 2000 RPM longer than necessary to test operation and observe engine instruments. Proper engine cooling depends upon forward speed of the aircraft. Discontinue testing if temperature or pressure limits are approached.

6. Instrument Indications

a. Oil Pressure: The oil pressure relief valve will maintain pressure within the specified limits if the oil temperature is within the specified limits and if the engine is not excessively worn or dirty. Fluctuating or low pressure may be due to dirt in the oil pressure relief valve or congealed oil in the system.

b. Oil Temperature: The oil cooler and oil temperature control valve will maintain oil temperature within the specified range unless the cooler oil passages or air channels are obstructed. Oil temperature above the prescribed limit may cause a drop in oil pressure, leading to rapid wear of moving parts in the engine.

c. Cylinder Head Temperature: Any temperature in excess of the specified limit may cause cylinder or piston damage. Cooling of the cylinders depends upon the cylinder baffles being positioned properly on the cylinder heads, barrels and in other locations in the pressure compartment to direct air between the

cylinder fins. Fuel and air mixture ratio will affect cylinder temperature. Excessively lean mixture causes overheating even when the cooling system is in good condition. High power and low air speed, or any slow speed flight operation, may cause overheating by reducing the cooling air flow. The engine depends upon ram air flow developed by the forward motion of the aircraft for adequate cooling.

d. **Battery Charging:** The ammeter should indicate a negative charging rate while the engine is being started. The ammeter reading should return to the positive side as soon as the engine starts and RPM increases. A low charging rate is normal after the initial recharging of the battery. A zero reading or negative reading with electrical load may indicate a malfunction in the alternator or regulator system.

CAUTION . . . The turbocharger does not have a separate oil temperature indicator. The oil temperature for the turbocharger is the same as that indicated by the engine oil temperature gauge. The engine oil must be warm, at least 75° F, before take-off to assure proper turbocharger operation. The engine must not be operated at high power until the oil has reached this temperature.

TAKEOFF

1. Position mixture to "FULL RICH". Where installed, cowl flaps should be in the "Open" position.
2. Position propeller control in "FULL INCREASE" RPM position.
3. Position fuel boost pump switch as instructed by aircraft manufacturer.
4. Slowly advance the throttle to "FULL OPEN" position, carefully monitoring manifold pressure. For standard day temperatures and normal engine oil operating temperatures, manifold pressure should not exceed the maximum rated limit when the throttle is "FULL OPEN". When taking off at full throttle and minimum engine oil temperature of 75°F, an increase in manifold

pressure above the rated maximum limit may occur due to the effect of cold oil upon the turbocharger control system. Under these conditions, a 1.0-2.0 inches Hg. increase in manifold pressure above the rated maximum limit is allowed for 2-3 minutes duration. Under normal operating conditions, if maximum rated take-off power is achieved before the throttle reaches full travel, do not advance the throttle lever further. Continued forward movement of the throttle may result in an engine "Overboost" condition.

WARNING . . . Continuous overboost operation may damage the engine and require engine inspection. See Service Bulletin M67-12.

When oil temperature and pressure have stabilized in the operating limits, and an increase in manifold pressure beyond the limits specified above occur; this is an indication that the turbocharger controller needs readjusting.

CAUTION . . . Avoid rapid throttle movement in order to reduce manifold pressure overboost.

CLIMB

1. Climb at 75% power and above must be accomplished with a "FULL RICH" mixture setting and cowl flaps, if provided, set to maintain desired temperature.
2. Reduce to climb power.
3. During climb observe manifold pressure and, if necessary, retard throttle to stay below maximum manifold pressure limits (red line).

NOTE . . . Generally, when the aircraft has been configured for climbout, engine power should be reduced. Recommended power for normal climb is 75% with a "FULL RICH" mixture setting. If power settings of greater than 75% are required, particular attention should be given to cylinder head, EGT, and oil temperatures, and mixture must be "FULL RICH".

WARNING . . . At power settings above 75%, do not use the E.G.T. gauge as an aid to adjust mixture. Mixture "FULL RICH" only. If you attempt to determine the "peak" E.G.T. while the engine is operating above 75% power, you may experience burned valves, detonation, and possible engine failure can occur.

CRUISE

1. Set Manifold pressure and RPM for cruise power selected.
2. When engine temperatures have stabilized at cruise condition (usually within 5 minutes after leveling off), adjust mixture to obtain specified fuel flow. See Engine Performance and Cruise Control section of this manual or aircraft manufacturer's instructions.
3. When a leaned mixture setting is used, and climb power is desired, the mixture control must be returned to "FULL RICH" before changing the throttle or propeller setting. When reducing power, retard throttle, adjust RPM and then adjust mixture as necessary.

NOTE . . . If an exhaust gas temperature gauge is used to monitor cruise fuel flow at 75% power and below, a cruise fuel mixture adjusted to 100°F to 150°F rich of peak will produce the best power setting, unless a specified setting is required for your particular model engine.

NOTE . . . Rapid throttle movements may cause undershooting or overshooting of the desired manifold pressure, necessitating a subsequent adjustment once the turbocharger has stabilized. Gradual throttle movement will permit the turbocharger to keep pace with the change in power. On pressurized aircraft, slower manifold pressure adjustment will prevent sudden "spikes" in cabin altitude. At high altitude, large reductions in manifold pressure may cause some reduction of cabin pressure.

DESCENT

Descent from high altitude should be accomplished at cruise power settings, with the mixture control positioned accordingly.

CAUTION . . . Rapid descents at high RPM and idle manifold pressure are to be avoided.

During descent, monitor cylinder head and oil temperatures, maintaining above the minimum specified limits.

NOTE . . . Avoid long descents at low manifold pressure, which can result in excessive engine cooling. Satisfactory engine acceleration may not occur when power is applied. If power must be reduced for long periods, adjust propeller to minimum governing RPM and set manifold pressure no lower than necessary to obtain desired performance. If the outside air is extremely cold, it may be desirable to add drag (gear, flaps) to the aircraft in order to maintain engine power without gaining excess airspeed. Do not permit cylinder temperature to drop below 300°F. for periods exceeding five (5) minutes.

LANDING

1. In anticipation of a go-around, with the need for high power settings, the mixture control should be set "FULL RICH" before landing.

NOTE . . . Advance mixture slowly toward "FULL RICH". If engine roughness occurs, as may happen at very low throttle settings and high RPM, it may be desirable to leave the mixture control approximately 3/4 open until the throttles are advanced above 15 inches of manifold pressure.

2. Operate the auxiliary fuel pump as instructed by aircraft manufacturer.

ENGINE SHUTDOWN

1. If auxiliary fuel pump has been "ON" for landing, turn to "OFF".
2. Operate the engine at idle for approximately five minutes to allow the turbochargers to cool off and slow down.

NOTE . . . Taxi time after landing may be considered part of the five minutes.

3. Place mixture control in "IDLE CUT-OFF".
4. Turn magnetos "OFF".

WARNING . . . Do not turn the propeller while ignition switch is in the "BOTH", "LEFT" or "RIGHT" position, since this could start the engine and cause injury. Do not turn the propeller of a hot engine, even though the ignition switch is in the "OFF" position; the engine could "KICK" as a result of auto-ignition from a small amount of fuel remaining in the cylinders.

NOTE . . . Good pilot technique is important for long engine life. Execute all control movements consistently in a smooth, positive manner.

SECTION IV

IN-FLIGHT EMERGENCY PROCEDURES

If a malfunction should occur in flight, certain remedial actions may eliminate or reduce the problem. Some malfunctions which might conceivably occur are listed in this section. Recommended corrective action is also included, however, it should be recognized that no single procedure will necessarily be applicable to every situation.

A thorough knowledge of the aircraft and engine systems will be an invaluable asset to the pilot in assessing a given situation and dealing with it accordingly.

ENGINE FIRE DURING START

If flames are observed in the induction or exhaust system during engine starting, follow the aircraft manufacturer's instructions in their Pilot's Operating Handbook.

ENGINE ROUGHNESS

Observe engine for visible damage or evidence of smoke or flame. Extreme roughness may be indicative of propeller blade failure. If any of these characteristics are noted, follow aircraft manufacturer's instructions.

1. Engine Instruments - Check. If abnormal indications appear, proceed according to Abnormal Engine Instrument Indications (this section).
2. Mixture - Adjust as appropriate to power setting being used. Do not arbitrarily go to "Full Rich", as the roughness may be caused by an over-rich mixture.
3. Magnetos - Check On.

If engine roughness does not disappear after the above, the following steps should be taken to evaluate the ignition system.

1. Throttle - Reduce power until roughness becomes minimal.
2. Magnetos - Turn Off, then On, one at a time. If engine smooths out while running on single ignition, adjust power as necessary and continue. Do not operate the engine in this manner any longer than absolutely necessary. The airplane should be landed as soon as practical and the engine repaired.

If no improvement in engine operation is noted while operating on either magneto, return all magneto switches to On.

CAUTION . . . The engine may quit completely when one magneto is switched off, if the other magneto is faulty. DO NOT turn magnetos immediately "ON". Close the throttle to idle and move the mixture to idle cutoff before turning the magnetos on. This may prevent a severe backfire from occurring. Once magnetos are turned back on, advance mixture and throttle to previous settings.

WARNING . . . If roughness is severe or if the cause cannot be determined, engine failure may be imminent. In this case, it is recommended that the aircraft manufacturer's emergency procedure be employed. In any event, further damage may be minimized by operating at a reduced power setting.

TURBOCHARGER FAILURE

Turbocharger failure will be evidenced by the inability of the engine to produce manifold pressure above ambient pressure. In this case the engine will revert to a "normally aspirated" condition and can be operated, but will produce less than its rated horsepower.

WARNING . . . If turbocharger failure occurs before takeoff, DO NOT fly the aircraft.

If turbocharger failure occurs in flight, the aircraft manufacturer's emergency instructions should be followed; if they are unavailable and the choice is made to continue operating the engine, proceed with the following to obtain the appropriate fuel flow for the manifold pressure and RPM.

WARNING . . . If turbocharger failure is a result of a loose, disconnected or burned-through exhaust, then a serious fire hazard may exist.

1. Mixture - Idle Cutoff.
2. Throttle - Normal Cruise.
3. Propeller Control - Normal Cruise RPM.
4. Mixture - Advance slowly. When the proper mixture ratio is reached, the engine will start. Continue to adjust the mixture control until the correct fuel flow for the manifold pressure and RPM is obtained.

NOTE . . . An interruption in fuel flow to the engine can cause engine failure due to turbocharger "run-down". At high altitude, merely restoring fuel flow may not cause the engine to restart, because the mixture will be excessively rich. If the engine does not restart, there will be insufficient mass flow through the exhaust to turn the turbine. This condition may give indications similar to a turbocharger failure. If a power loss is experienced followed by surging of RPM, fuel flow and manifold pressure, follow aircraft manufacturer's instructions for restart.

ABNORMAL ENGINE INSTRUMENT INDICATIONS

HIGH CYLINDER HEAD TEMPERATURE

1. Mixture - Increase fuel flow.
2. Cowl Flaps - Open.
3. Airspeed - Increase to normal climb or cruise speed.

CAUTION . . . If temperature cannot be maintained within limits, reduce power, land as soon as practical, and have the engine inspected before further flight.

HIGH OIL TEMPERATURE

NOTE . . . Prolonged high oil temperature indications will usually be accompanied by a drop in oil pressure. If oil pressure remains normal, then a high temperature indication may be caused by a faulty gauge or thermocouple. If the oil pressure drops as temperature increases, proceed as follows:

1. Cowl Flaps - Open.
2. Airspeed - Increase to normal climb or cruise speed.
3. Power - Reduce if steps 1 and 2 do not lower oil temperature.

CAUTION . . . If these steps do not restore oil temperature to normal, an engine failure or severe damage can result. In this case it is recommended that the aircraft manufacturer's instructions be followed.

LOW OIL PRESSURE

CAUTION . . . If the oil pressure drops unexplainably from the normal indication, monitor temperature and pressure closely and have the engine inspected at termination of the flight.

WARNING . . . If oil pressure drops below 30 p.s.i., an engine failure should be anticipated. Follow aircraft manufacturer's instructions.

IN-FLIGHT RESTARTING

CAUTION . . . Do not attempt to start the engine above an altitude of 20,000 feet using the starter, due to the possibility of magneto distributor block corrosion or burning.

CAUTION . . . Actual shutdown of an engine for practice or training purposes should be minimized. Whenever engine failure is to be simulated, it should be done by reducing power.

Whenever a turbocharged engine is shut down in flight, or when fuel flow is interrupted, the turbocharger will "run down" due to lack of mass flow through the exhaust system. If the mixture is placed in "FULL RICH" during restart attempts at high altitude, the fuel flow may be excessive and the engine may fail to start due to an over-rich mixture. The amount of richness will depend primarily on altitude.

The key point in restarting is to increase fuel flow gradually from idle cutoff so the engine will start when a proper mixture is reached. As the mass flow through the exhaust system increases, the turbocharger will spin up and provide increased manifold pressure. The mixture may then be increased and power adjusted as desired.

CAUTION . . . A few minutes exposure to temperatures and air-speeds at flight altitudes can have the same effect on an inoperative engine as hours of cold-soak in sub-Arctic conditions. If the engine must be restarted, consideration should be given to descending to warmer air. Closely monitor for excessive oil pressure as the propeller is unfeathered. Allow the engine to warm-up at minimum governing RPM and 15 inches Hg. (manifold pressure).

The following procedure is recommended for in-flight restarting:

1. Mixture - IDLE CUT-OFF.
2. Fuel Selector Valve - ON.
3. Fuel Boost Pump - ON.
4. Alternator Switch - OFF.
5. Throttle - NORMAL COLD START POSITION (1/2open).
6. Propeller Control - MOVE FORWARD OF THE FEATHERING DETENT TO MID-RANGE.
7. Magneto/Start Switch - START.
8. Mixture - FORWARD AS ENGINE STARTS.
9. Throttle - AS NECESSARY TO PREVENT OVERSPEED; Warm-up at 15 in. Hg. manifold pressure.
10. Oil Pressure, Oil and Cylinder Head Temperatures - NORMAL INDICATION.
11. Alternator Switch - ON.
12. Power - AS REQUIRED.

ENGINE FIRE IN-FLIGHT

1. Follow aircraft manufacturer's instructions.

SECTION V

ENGINE PERFORMANCE AND CRUISE CONTROL

The performance curves in this section are provided as a general reference in establishing power conditions for takeoff, climb and cruise operation. Refer to aircraft manufacturer's flight manual for recommended power settings and tabular climb and cruise data.

CRUISE CONTROL BY E.G.T./T.I.T.

Exhaust Gas Temperature (E.G.T.) is measured at the turbocharger turbine inlet and is commonly referred to as T.I.T. (Turbine Inlet Temperature).

To establish cruise lean mixture, proceed as follows:

1. Adjust manifold pressure and RPM for desired cruise setting.
2. Slowly move mixture toward "lean" while observing E.G.T./T.I.T. gauge. Note position on the instrument where the needle "peaks" or starts to drop as mixture is leaned further.

CAUTION . . . Do not continue to lean mixture beyond that which is necessary to establish peak temperature or 1650°F., whichever occurs first.

3. Enrich mixture to 25°F. rich of peak. At cruise settings below 65%, engine operation may be performed at peak E.G.T./T.I.T. Fuel flow gauge indications should fall within the maximum and minimum values shown on the fuel flow curve. If the values are not within tolerances, the fuel injection system or instrumentation (including tachometer, manifold pressure, fuel flow gauge or E.G.T./T.I.T. system) should be checked for maladjustments or calibration error. (See performance charts).

CAUTION . . . Do not attempt to adjust mixture by using E.G.T. or T.I.T. at power settings above maximum recommended cruise. Also, remember that engine power will change with ambient conditions. Changes in altitude or outside air temperature will require adjustments in manifold pressure and fuel flow. (Refer to Fuel Flow Vs. BHP charts).

Set mixture to "Full Rich" for changes in altitude and power settings which will constitute E.G.T./T.I.T. and mixture changes.

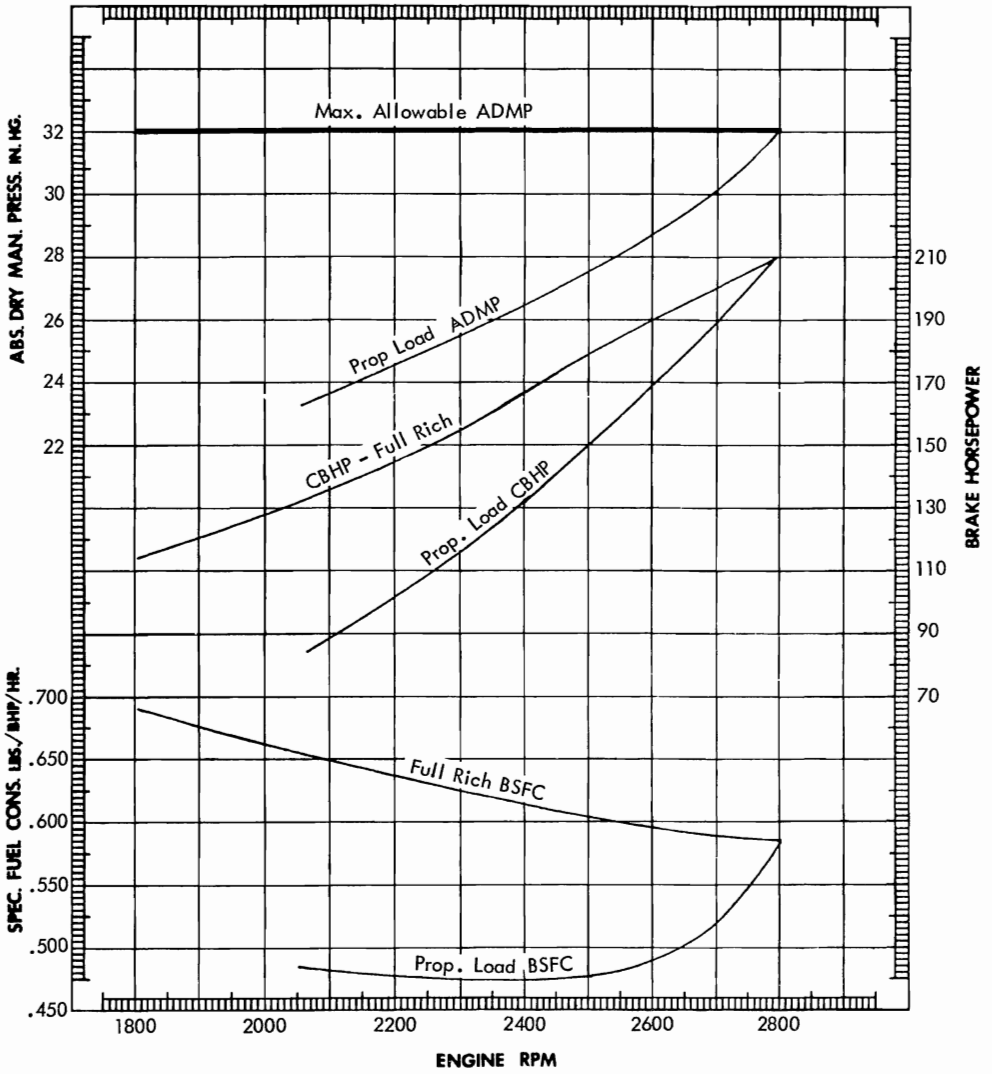
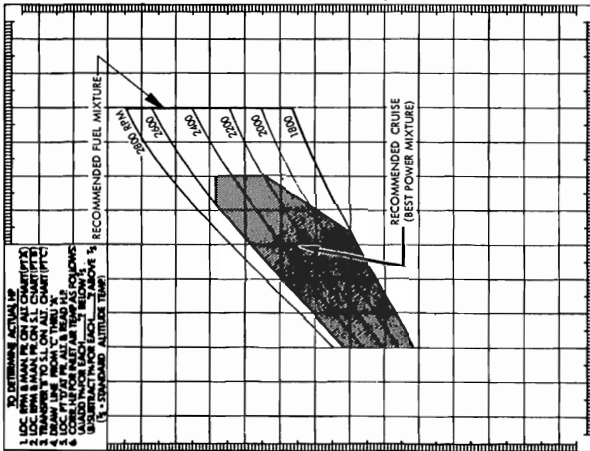
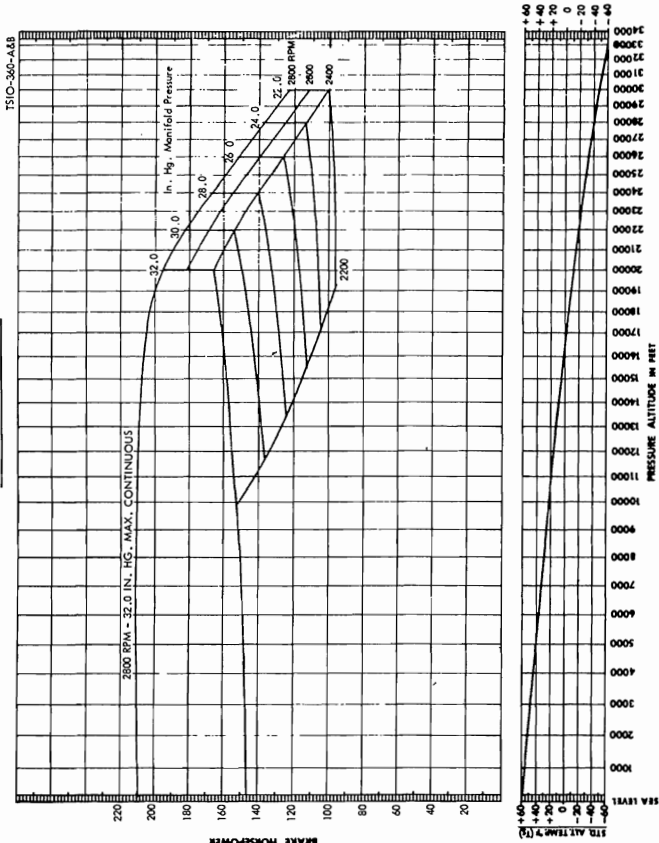

FIGURE 1
SEA LEVEL PERFORMANCE CURVES
TSIO-360-A, AB, B, BB

SEA LEVEL PERFORMANCE



ALTITUDE PERFORMANCE



**FIGURE 11
ALTITUDE PERFORMANCE CURVES
TSIO-360-A, AB, B, BB**

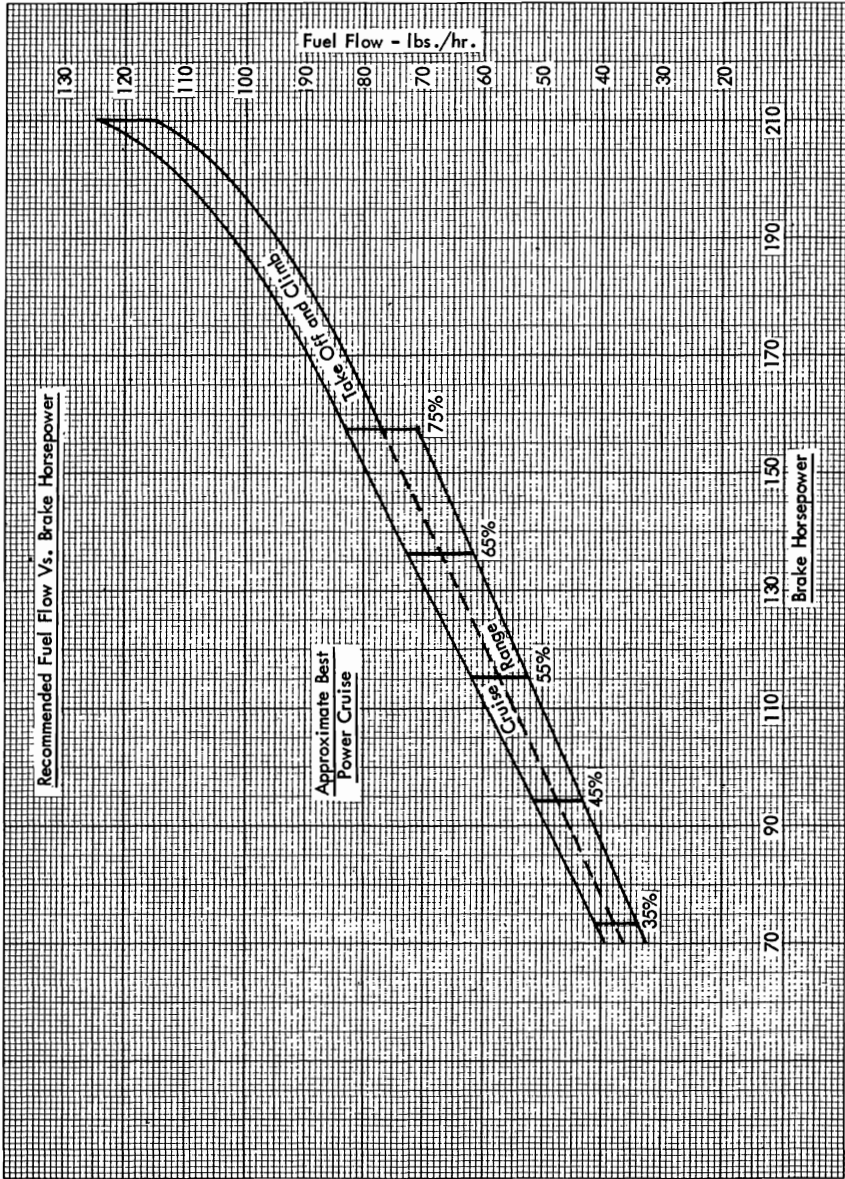

FIGURE 3
FUEL FLOW VS. BHP
TSIO-360-A, AB, B, BB

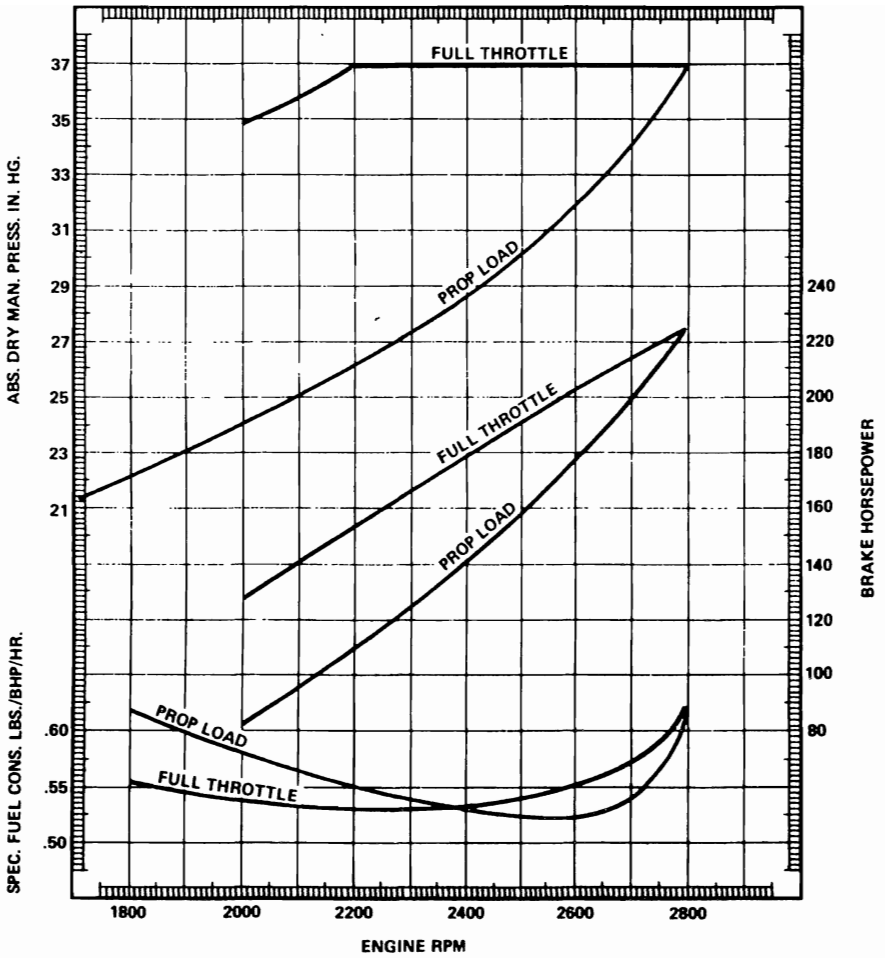

FIGURE 4
SEA LEVEL PERFORMANCE CURVES
TSIO-360-C, CB

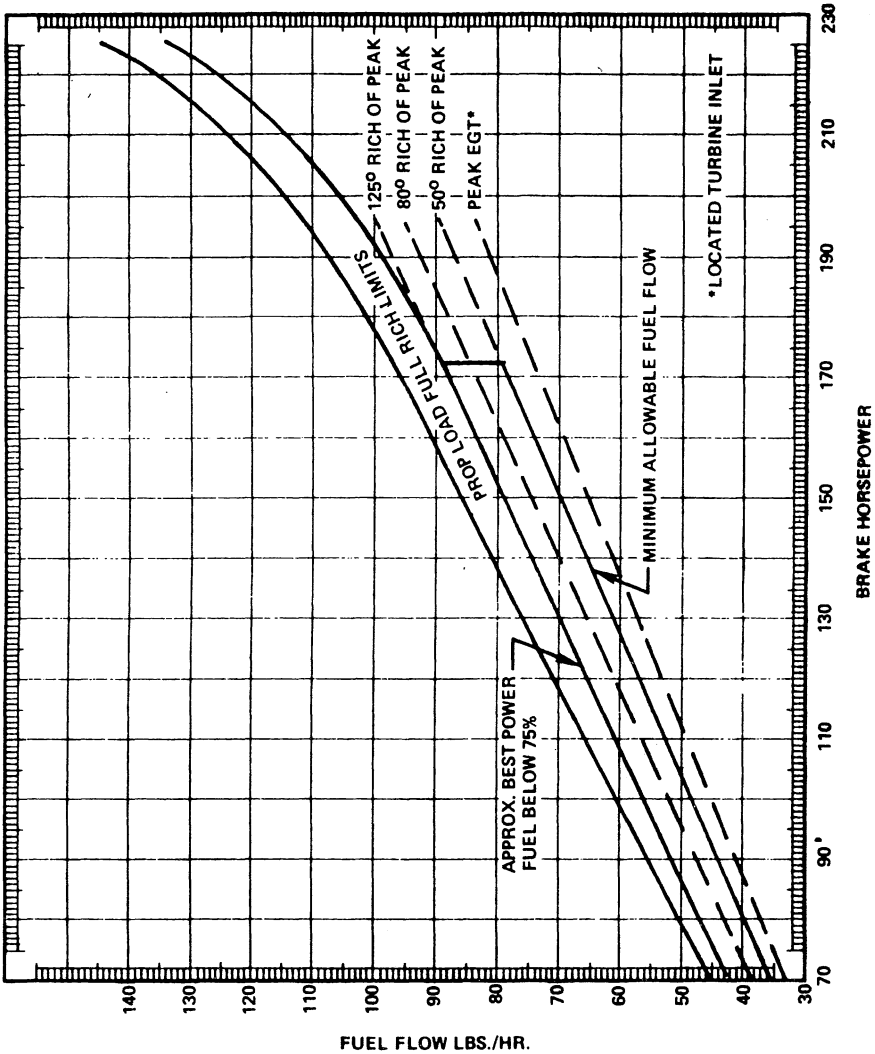

FIGURE 6
FUEL FLOW VS. BHP
TSIO-360-C, CB

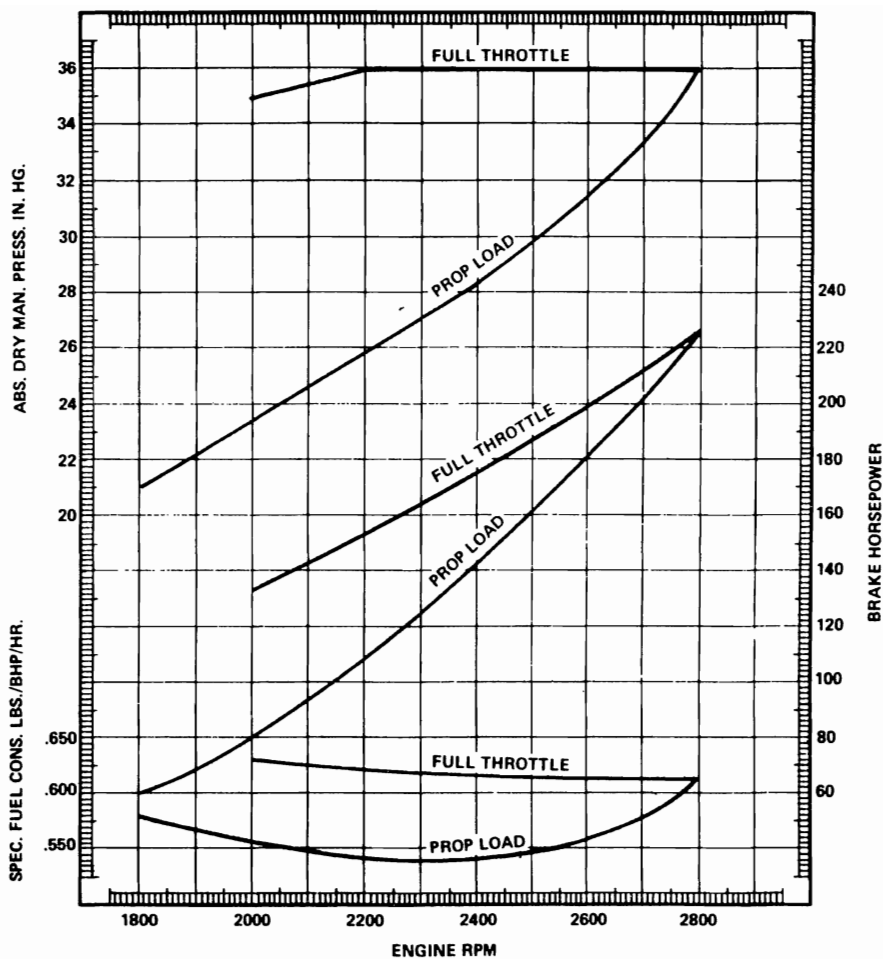
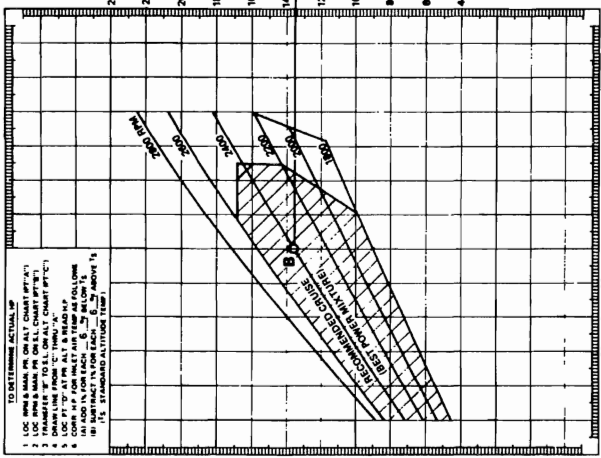

FIGURE 7
SEA LEVEL PERFORMANCE CURVES
TSIO-360-D, DB

SEA LEVEL PERFORMANCE



ALTITUDE PERFORMANCE

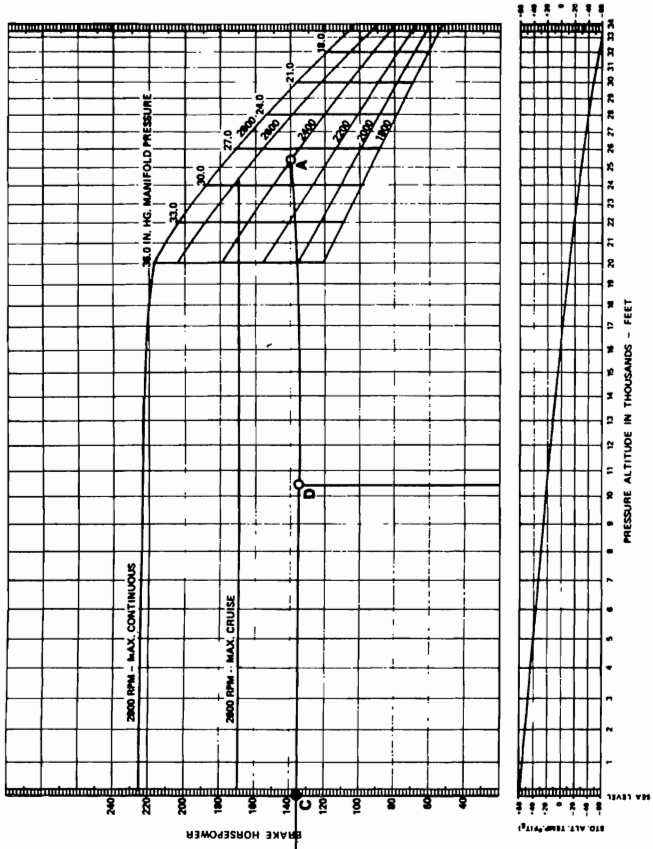

FIGURE 8
 ALTITUDE PERFORMANCE CURVES
 TSIO-360-D, DB

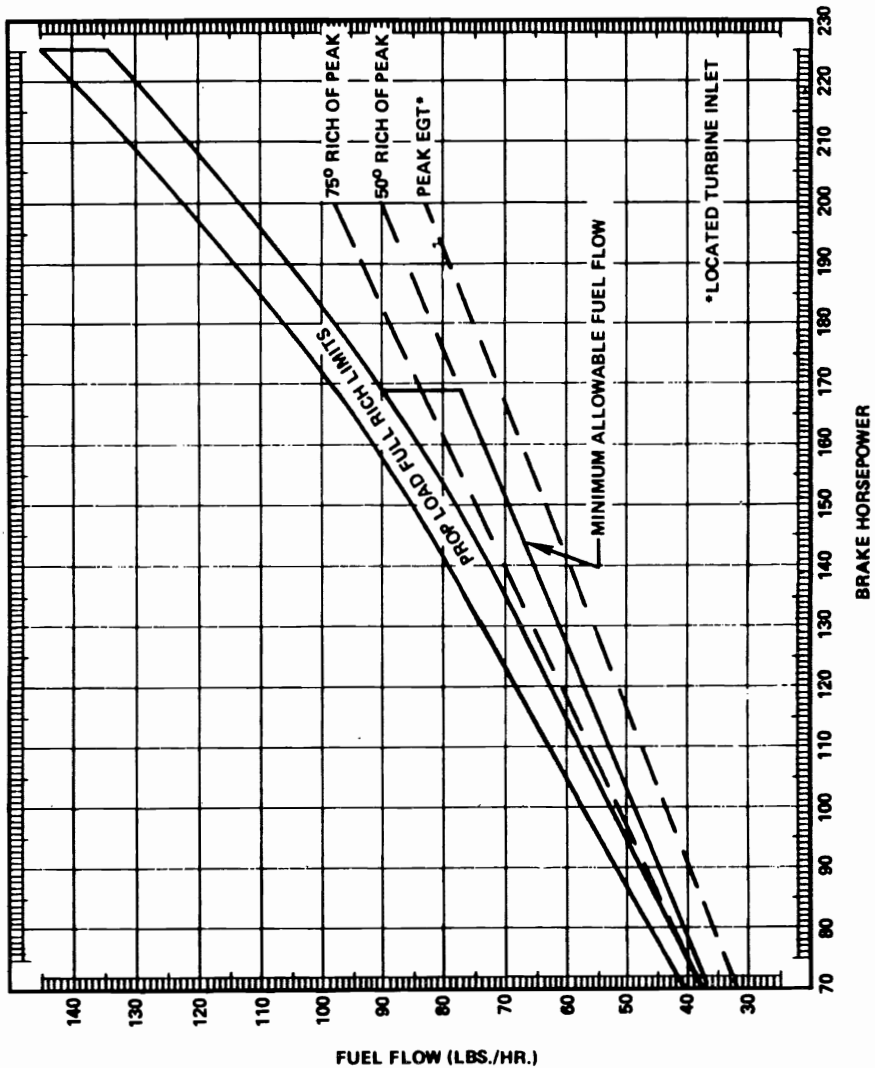

FIGURE 9
FUEL FLOW VS. BHP
TSIO-360-D, DB

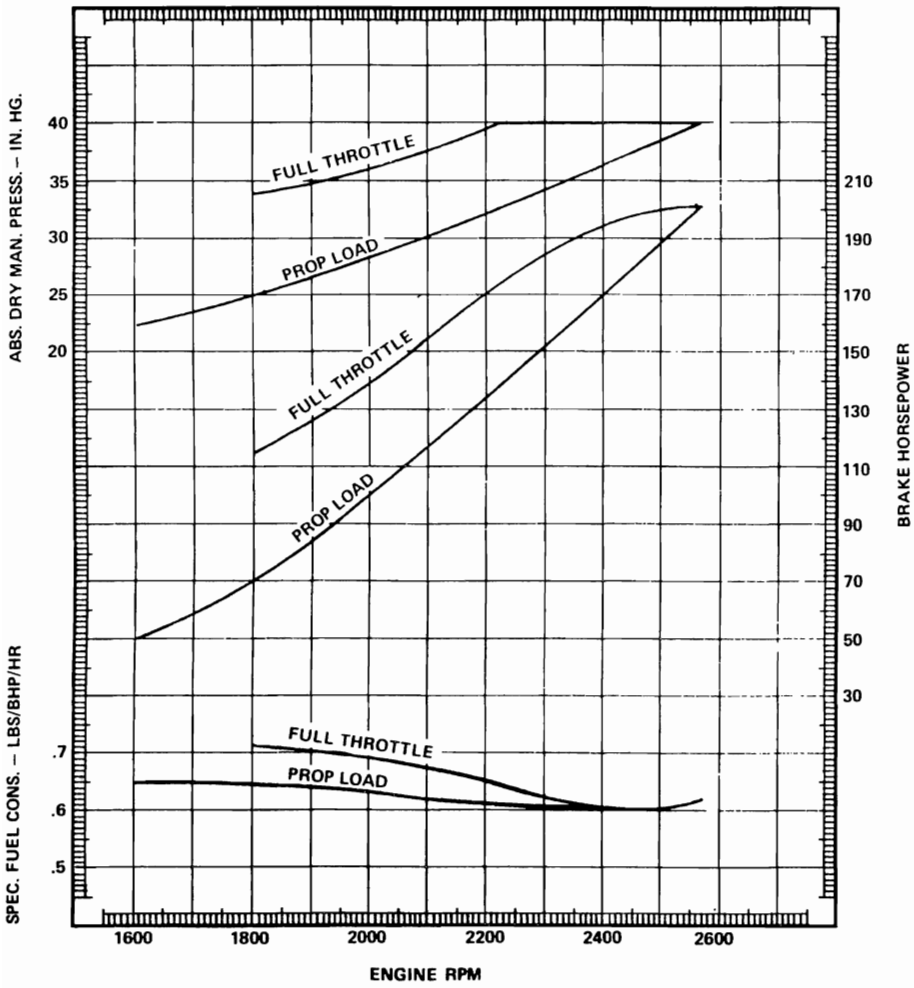
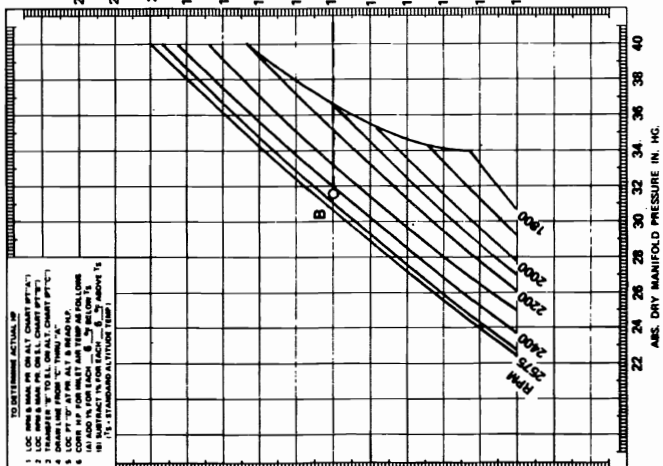
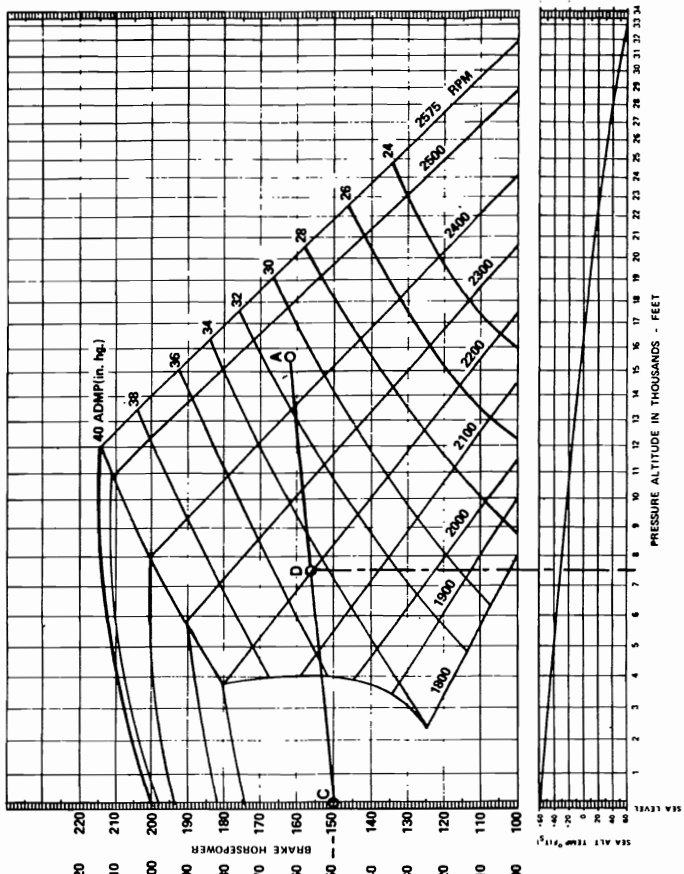

FIGURE 10
SEA LEVEL PERFORMANCE CURVES
L/TSIO-360-E, EB

SEA LEVEL PERFORMANCE



ALTITUDE PERFORMANCE



**FIGURE 2
ALTITUDE PERFORMANCE CURVES
L/TSIO-360-E, EB**

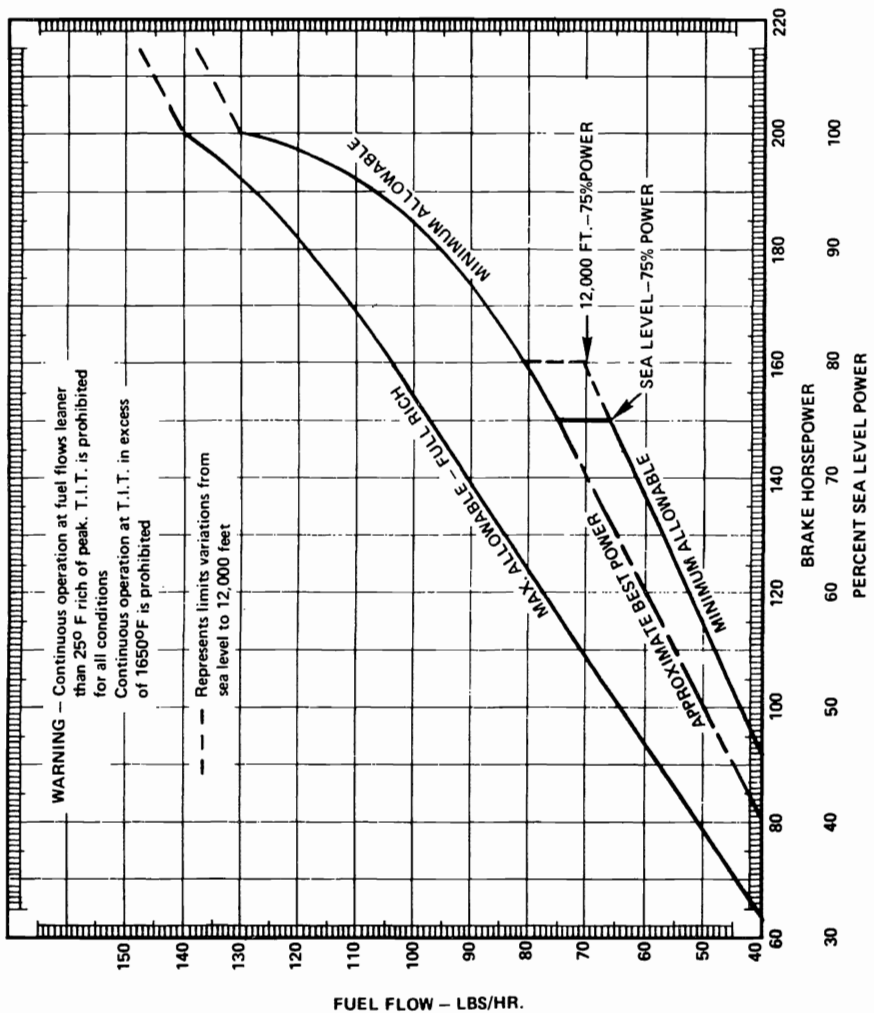

FIGURE 12
FUEL FLOW VS. BHP
L/TSIO-360-E, EB

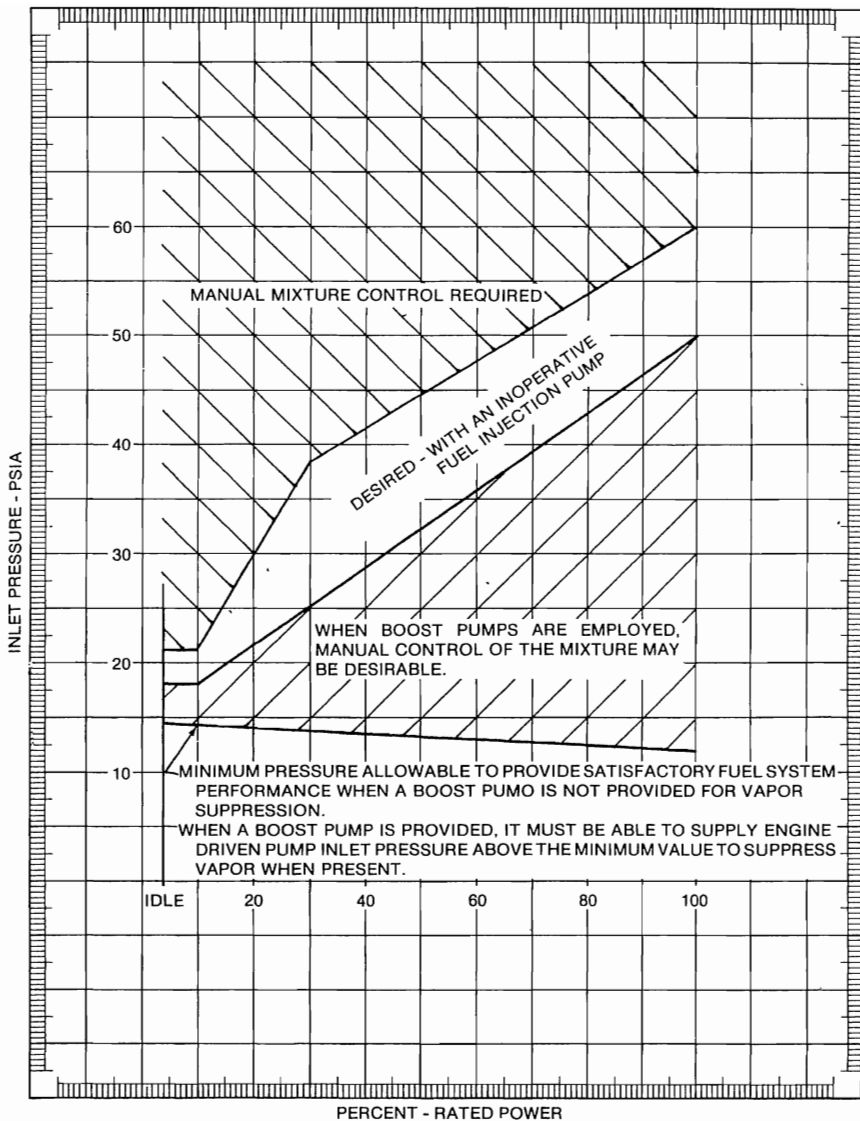

FIGURE 13
FUEL PUMP INLET PRESS. VS. % BHP
110°F AVGAS
L/TSIO-360-E, EB

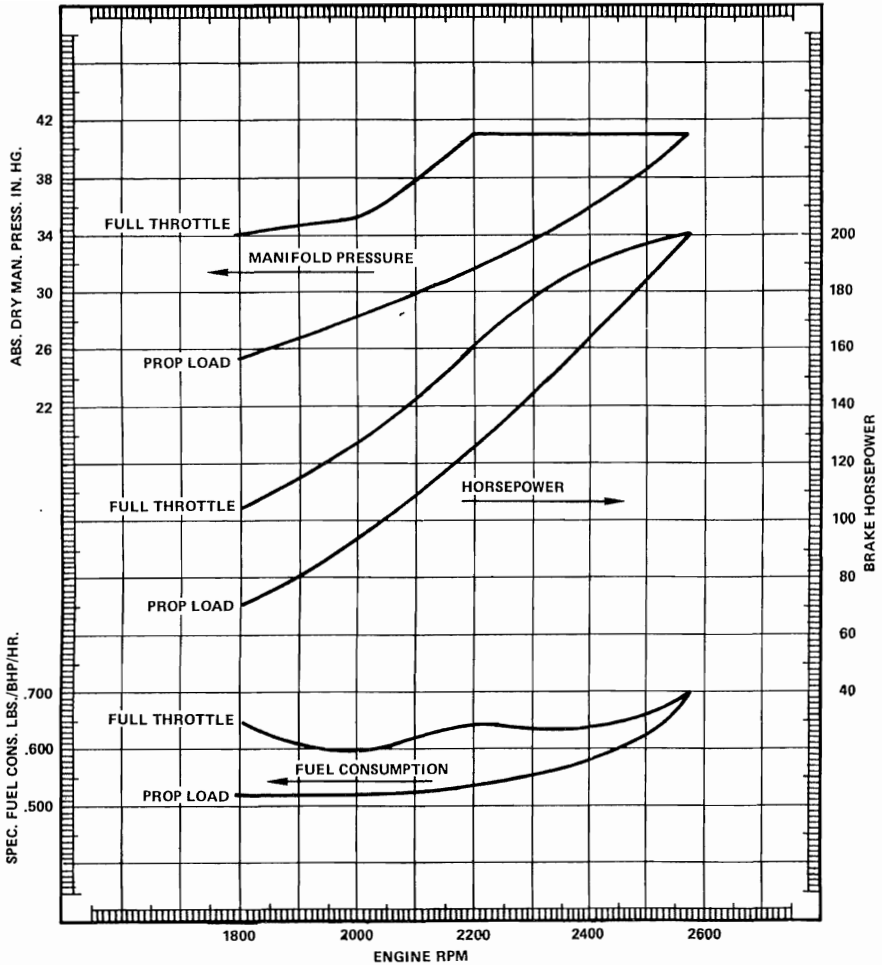
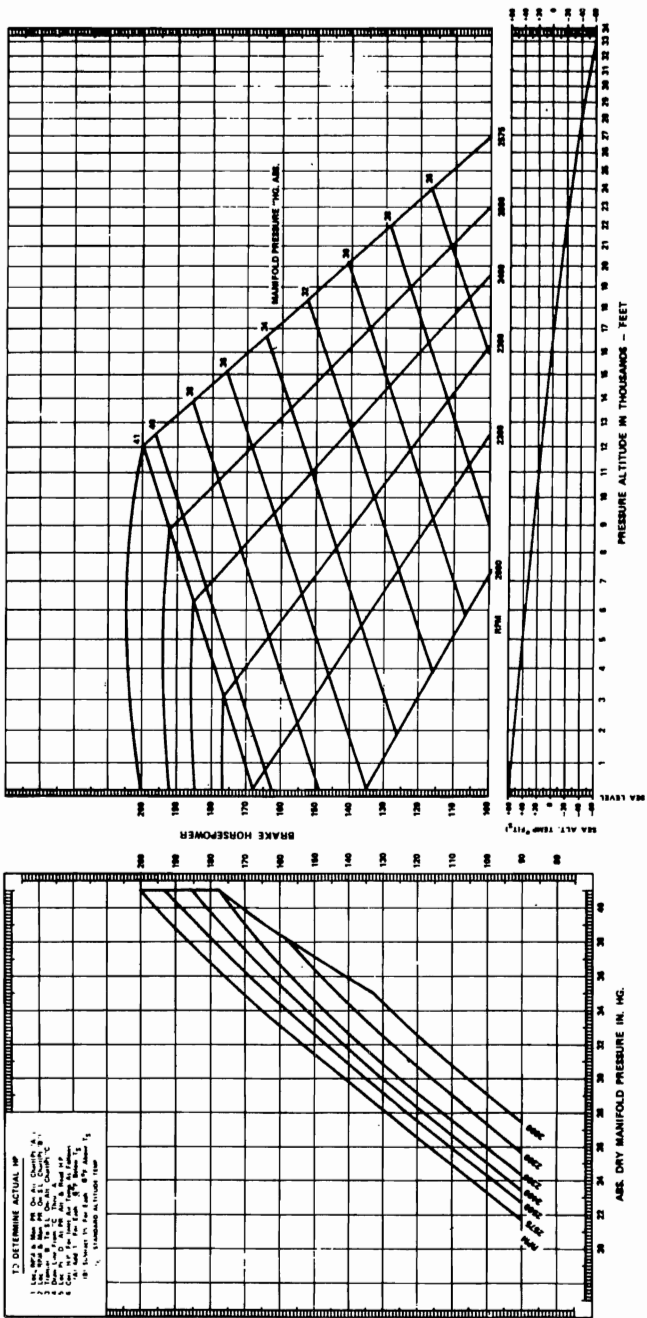
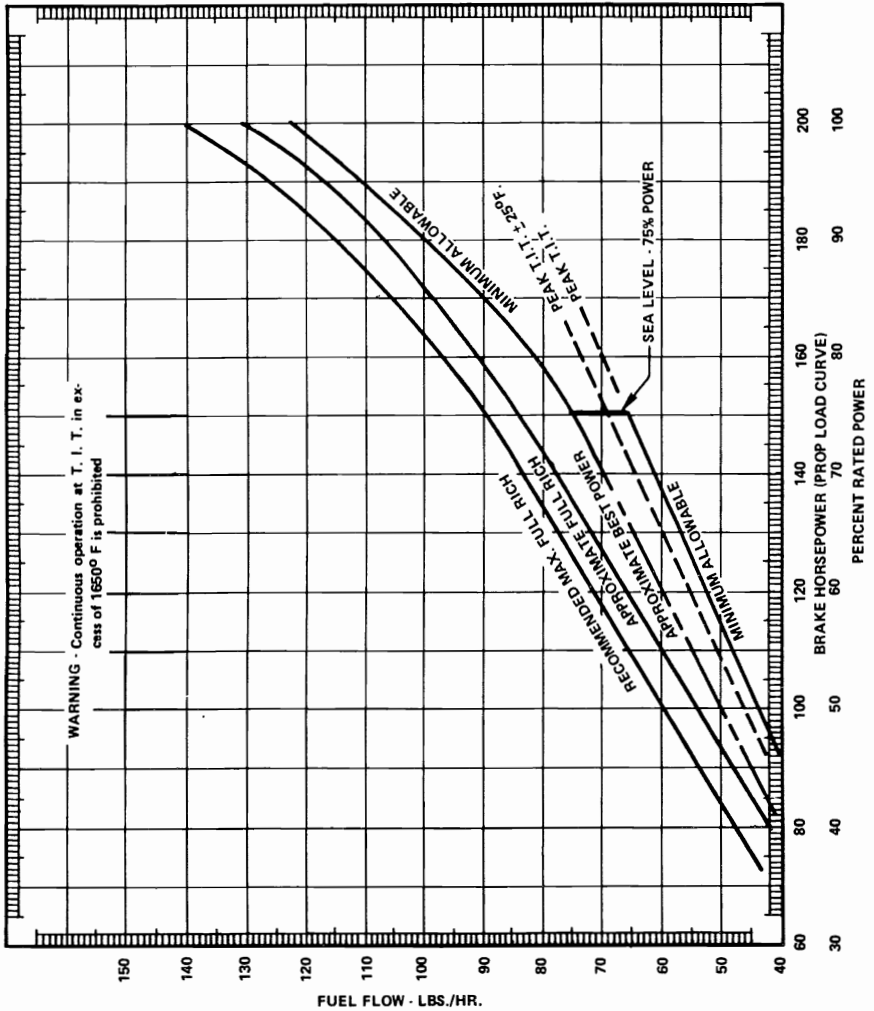

FIGURE 14
SEA LEVEL PERFORMANCE CURVES
TSIO-360-F, FB



**FIGURE 15
ALTITUDE PERFORMANCE CURVES
TSIO-360-F, FB**



**FIGURE 16
FUEL FLOW VS. BHP
TSIO-360-F, FB**

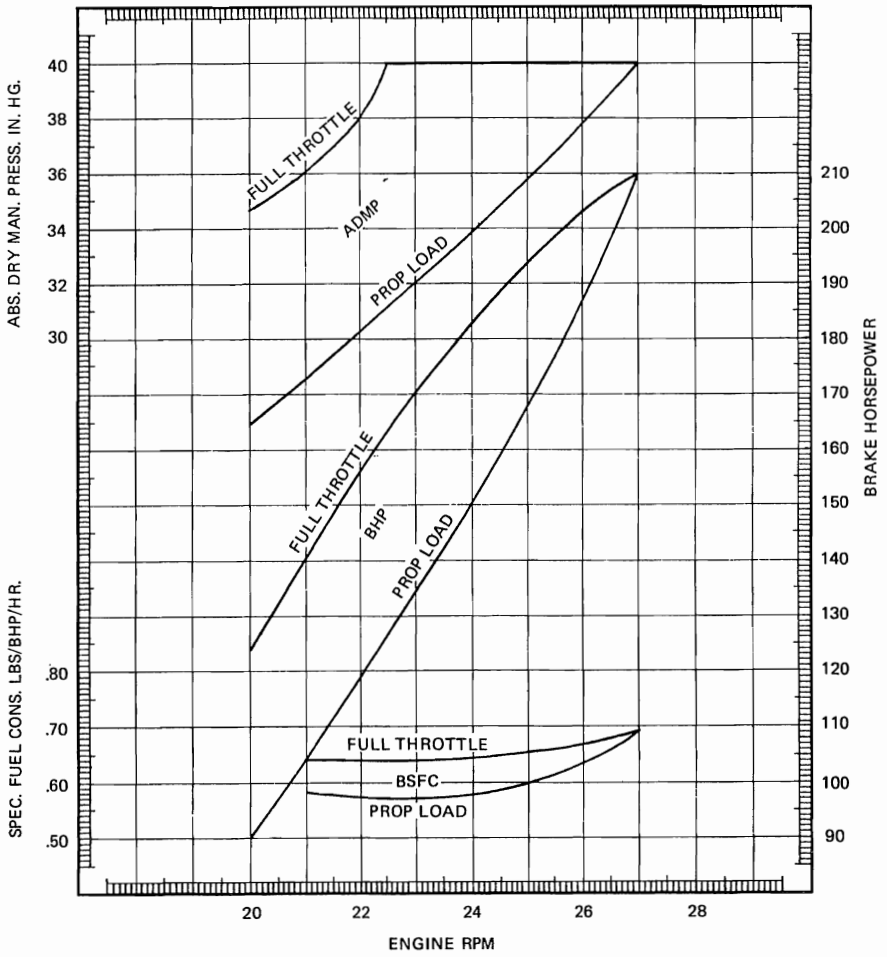

FIGURE 17
SEA LEVEL PERFORMANCE CURVES
TSIO-360-GB

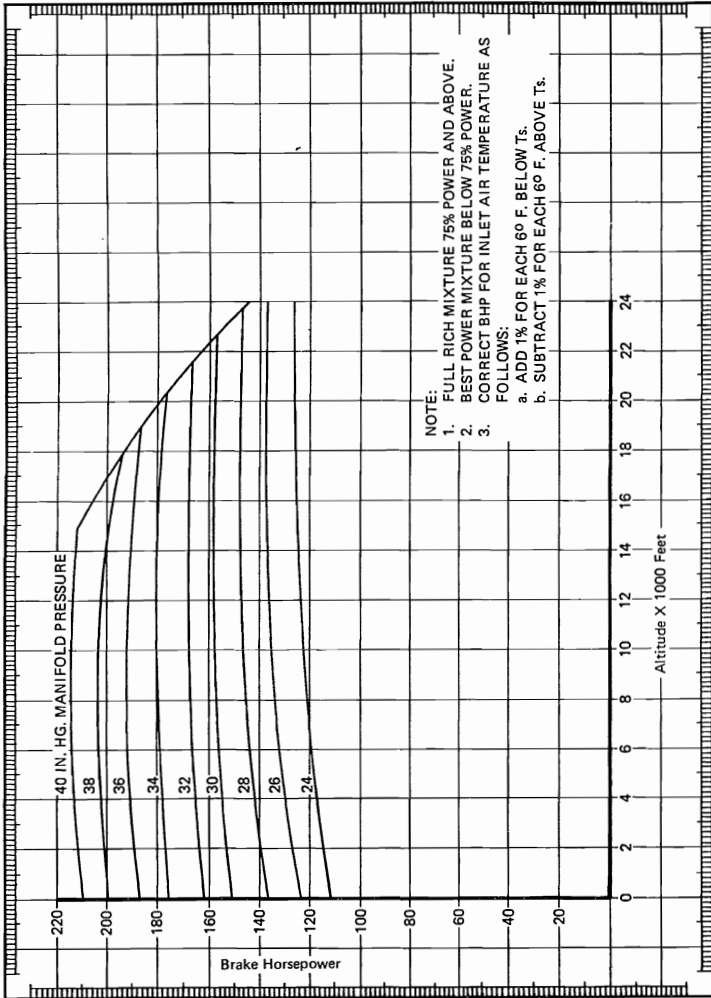

FIGURE 18
ALTITUDE PERFORMANCE
2700 RPM
TSIO-360-GB
5-20

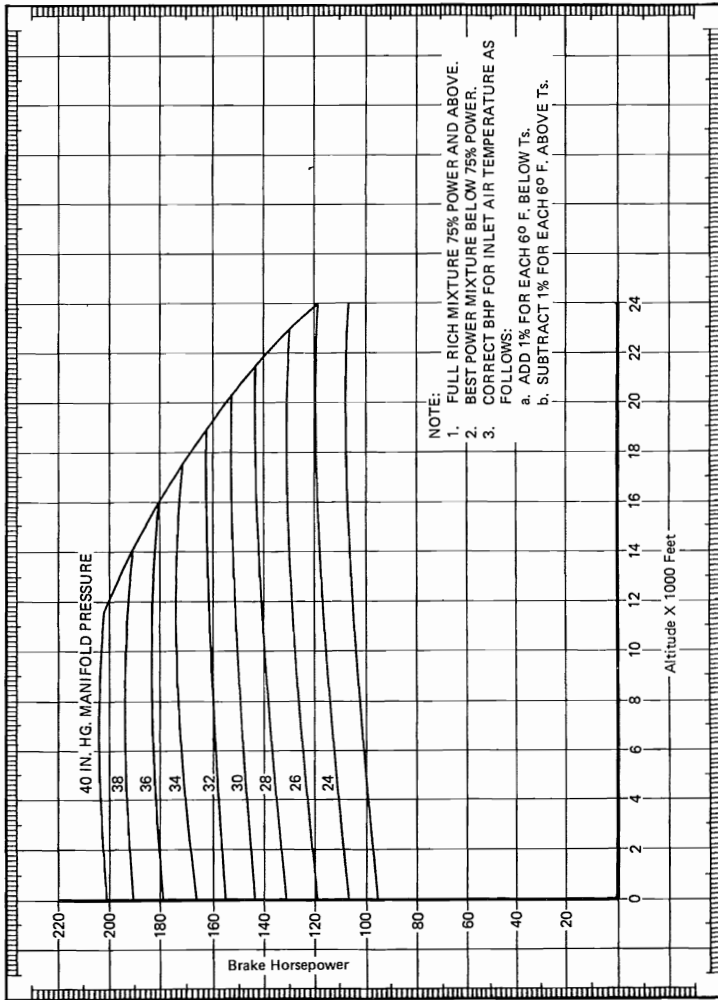

FIGURE 19
ALTITUDE PERFORMANCE
2600 RPM
TSIO-360-GB

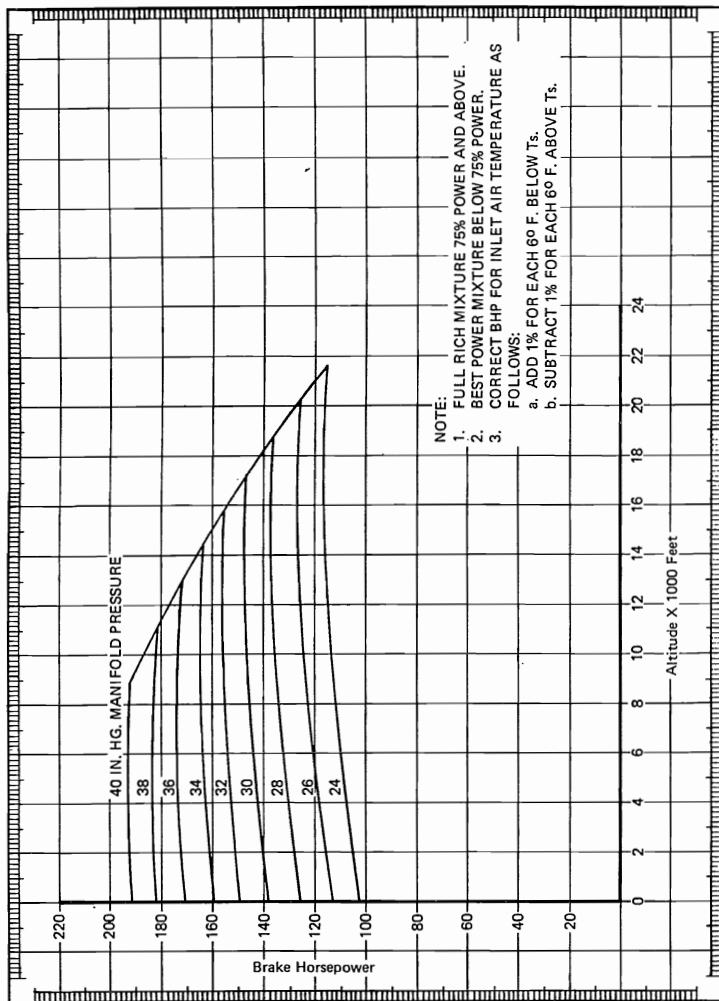

FIGURE 20
ALTITUDE PERFORMANCE
2500 RPM
TSIO-360-GB

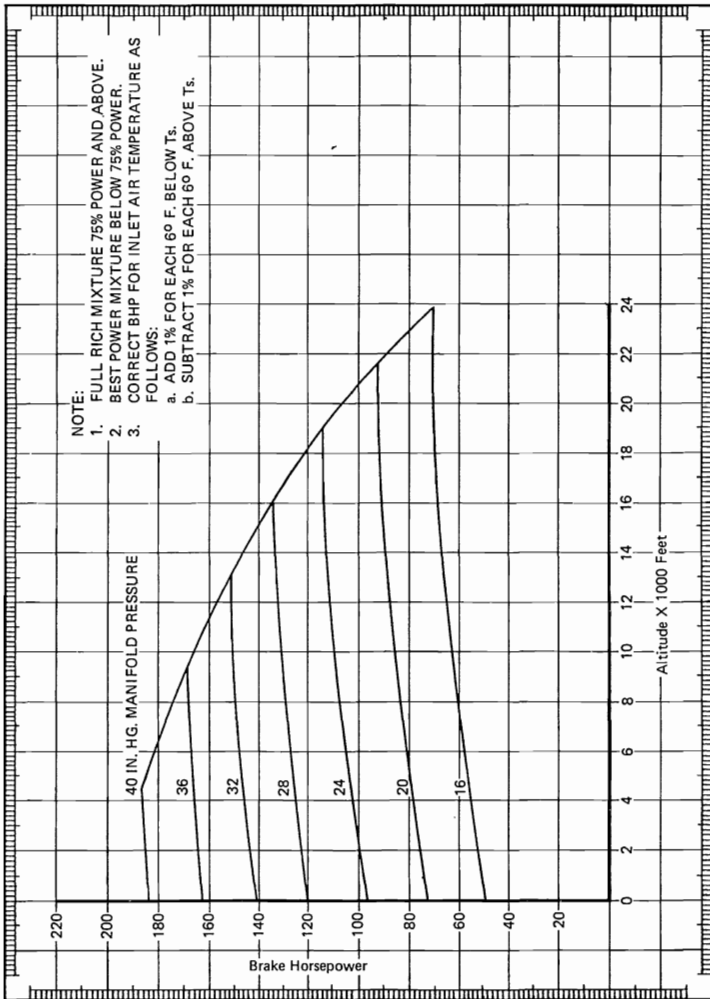

FIGURE 21
ALTITUDE PERFORMANCE
2400 RPM
TSIO-360-GB

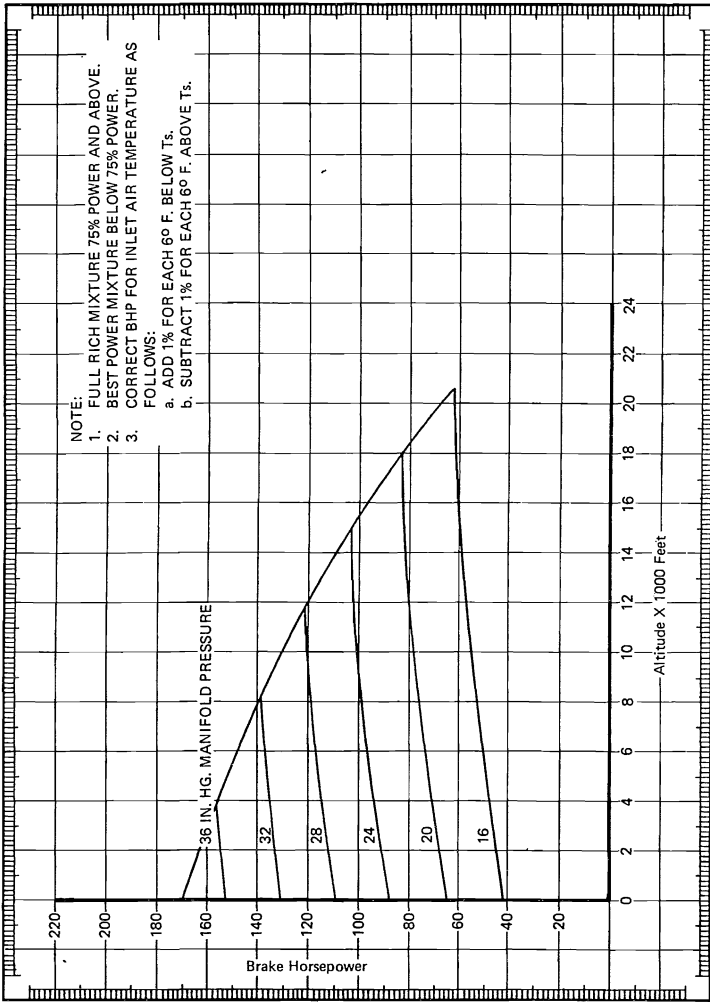
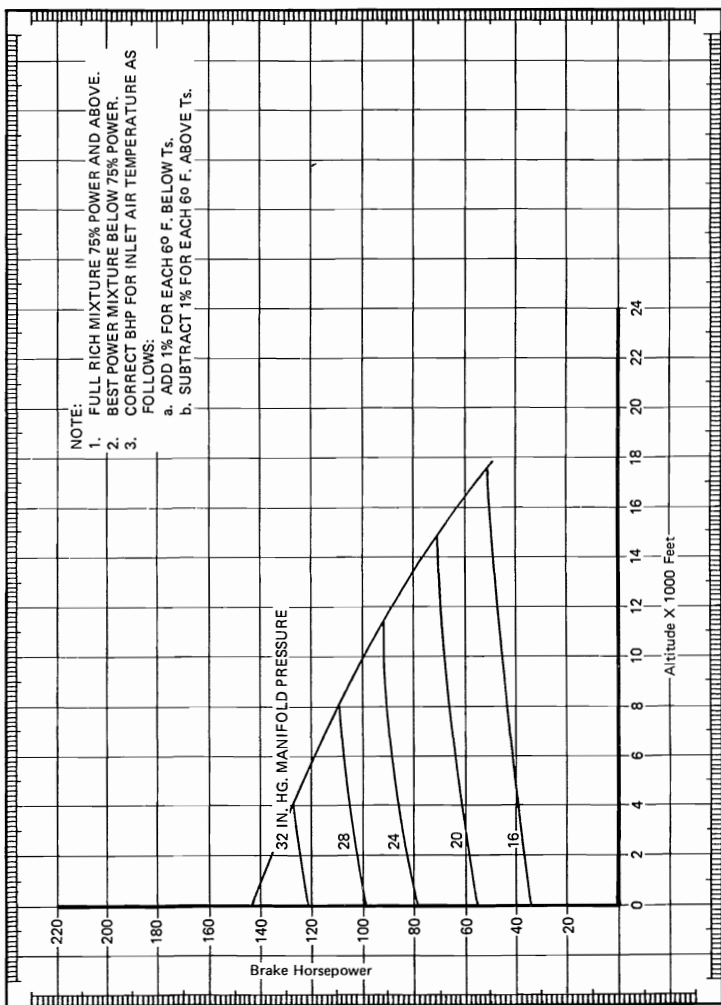

FIGURE 22
ALTITUDE PERFORMANCE
2200 RPM
TSIO-360-GB



**FIGURE 23
 ALTITUDE PERFORMANCE
 2000 RPM
 TSIO-360-GB**

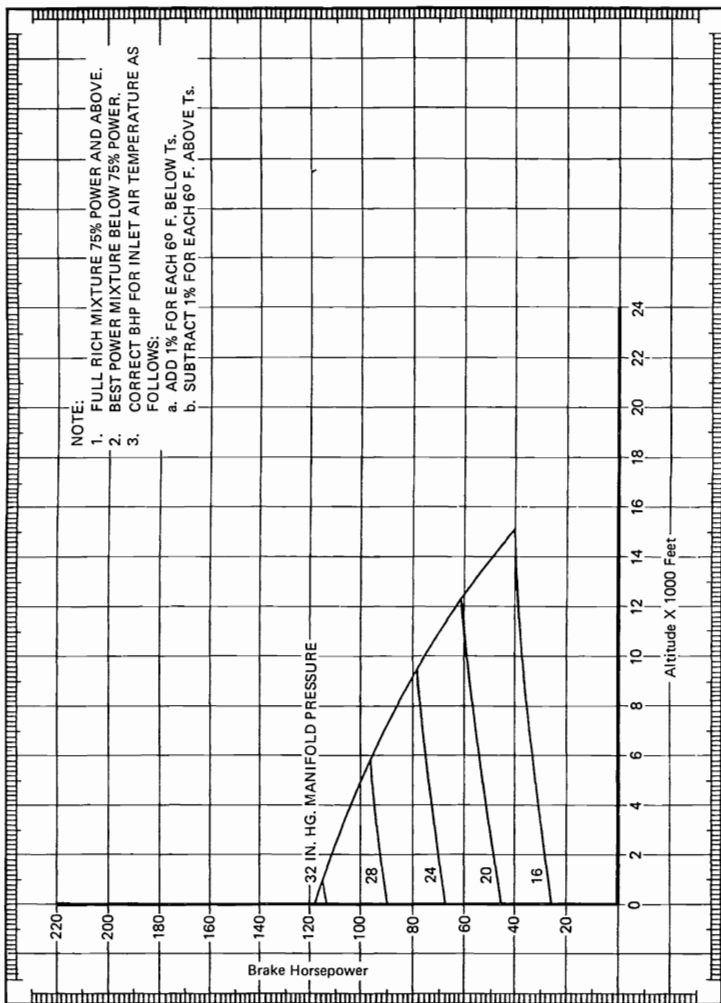

FIGURE 24
ALTITUDE PERFORMANCE
1800 RPM
TSIO-360-GB

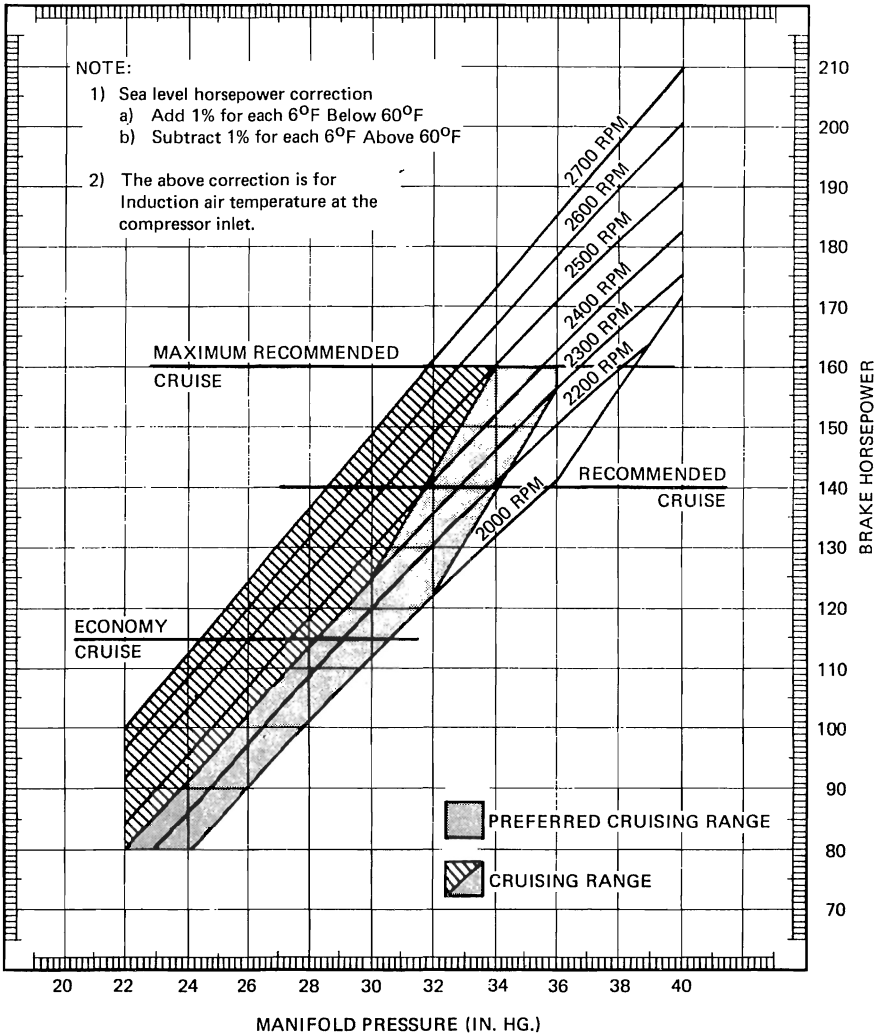

FIGURE 25
POWER MANAGEMENT OPERATING
RECOMMENDATIONS
TSIO-360-GB

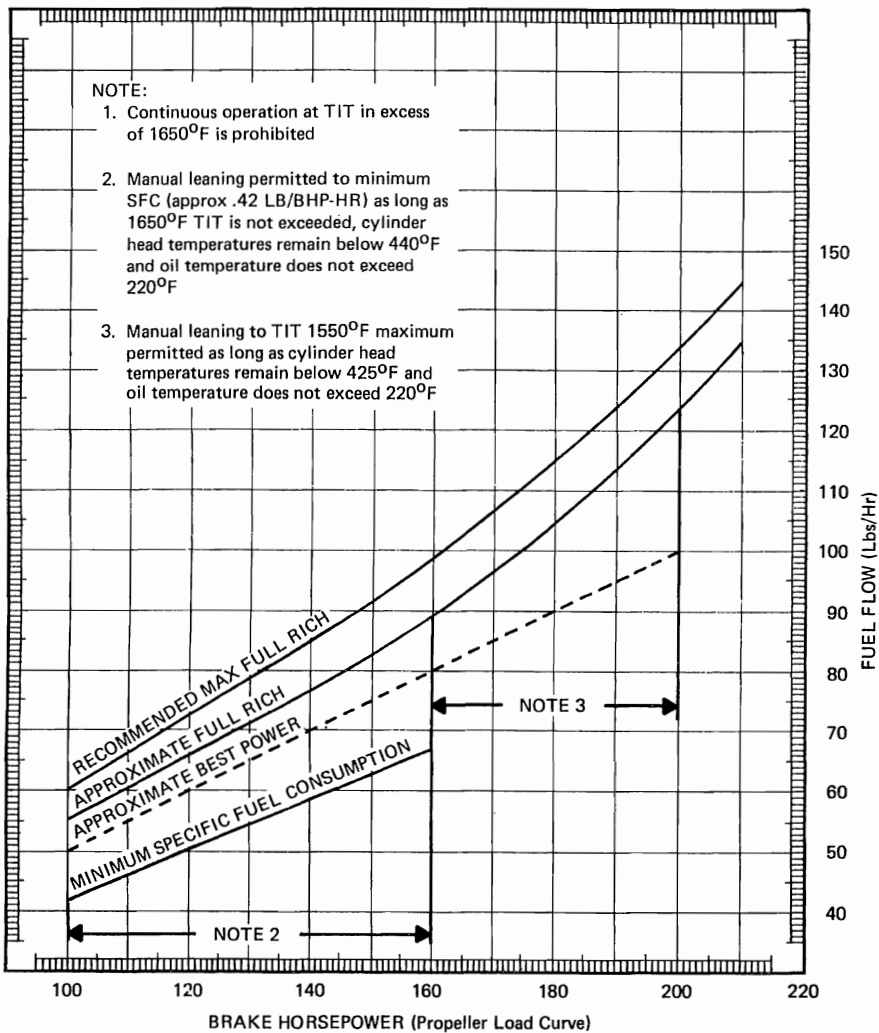

FIGURE 26
FUEL FLOW VS. BHP
TSIO-360-GB

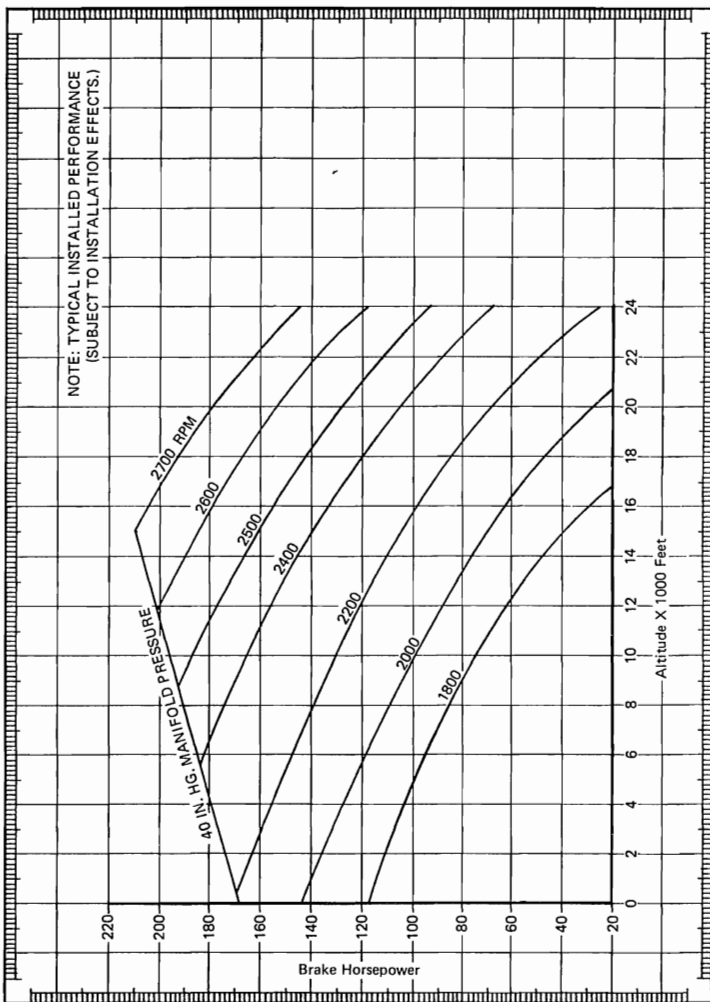

FIGURE 27
CRITICAL ALTITUDE VS. ENGINE SPEED
(STANDARD DAY)
TSIO-360-GB

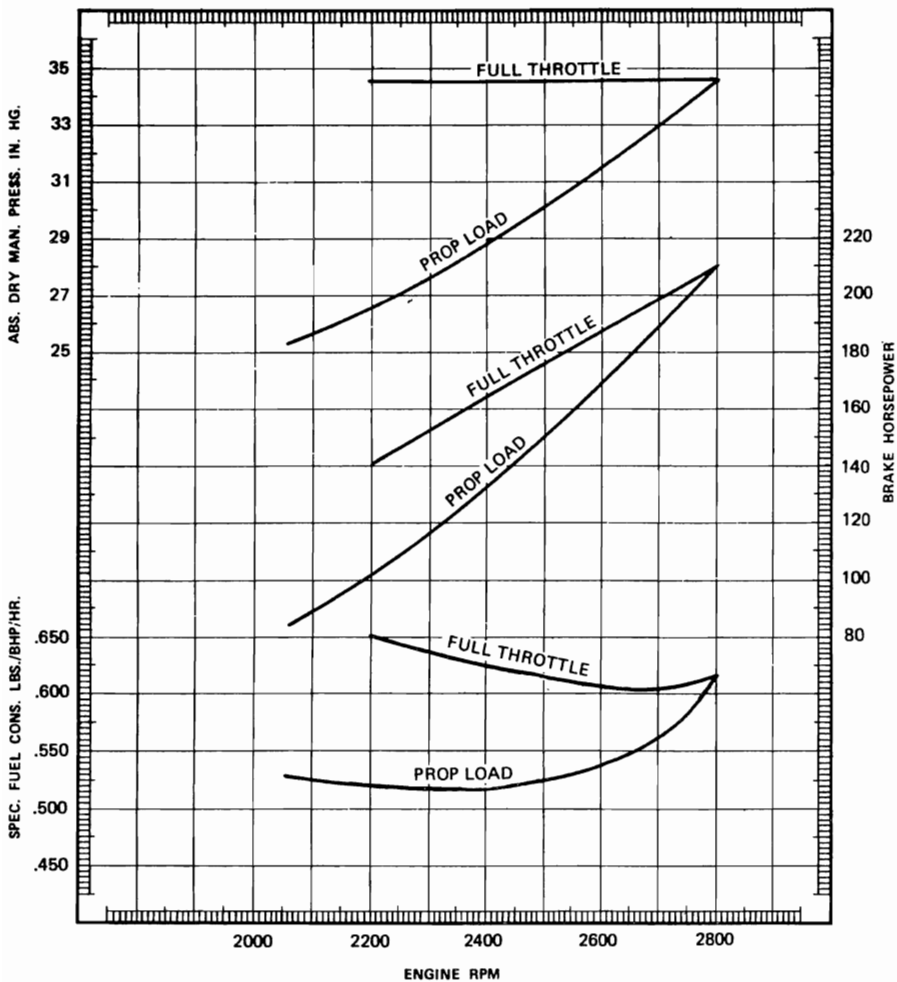

FIGURE 28
SEA LEVEL PERFORMANCE CURVES
TSIO-360-H, HB

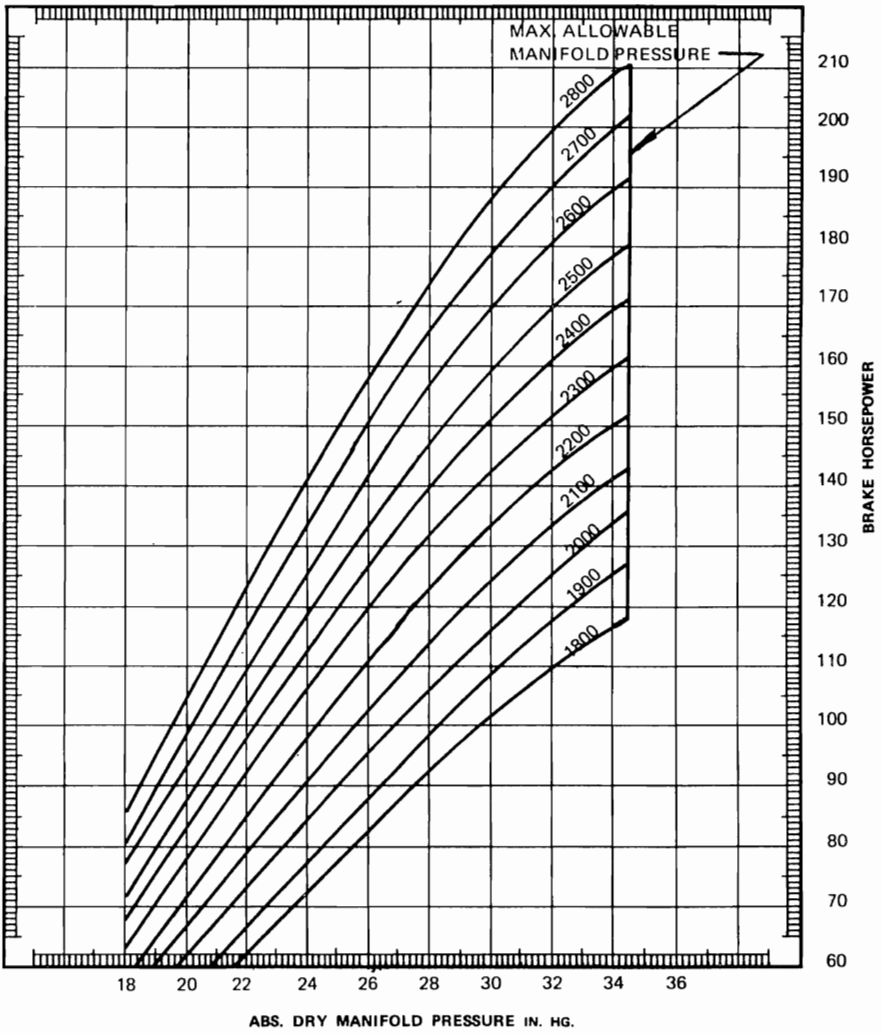
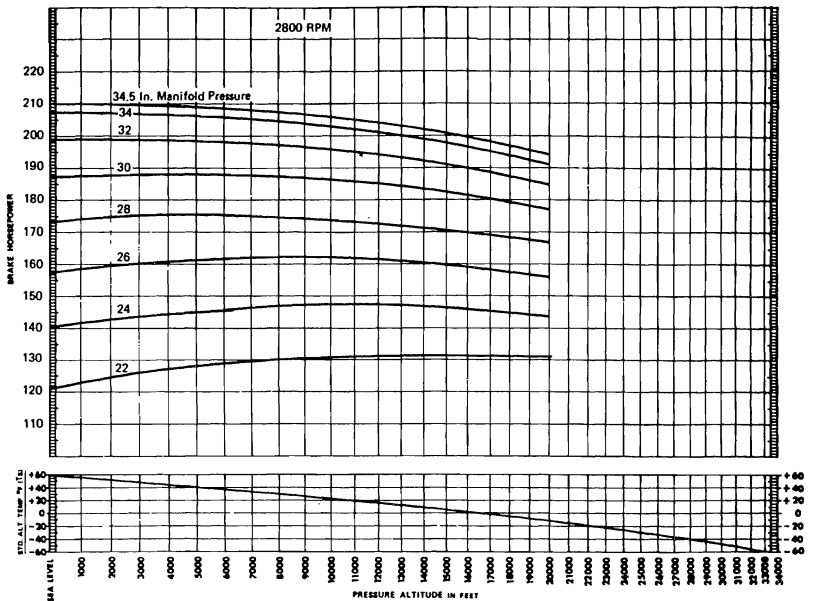
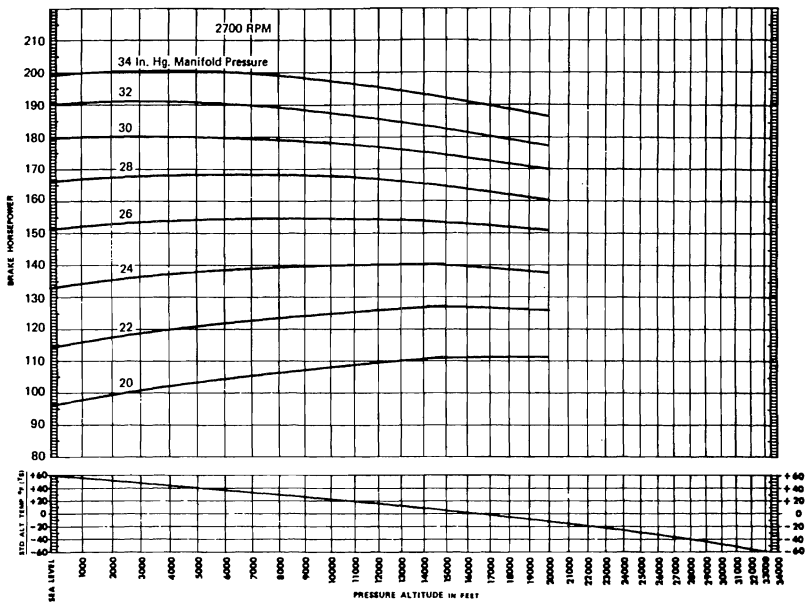

FIGURE 29
SEA LEVEL PERFORMANCE TO ALTITUDE
TSIO-360-H, HB



**FIGURE 30
ALTITUDE PERFORMANCE AT 2800 RPM
TSIO-360-H, HB**



**FIGURE 31
ALTITUDE PERFORMANCE AT 2700 RPM
TSIO-360-H, HB**

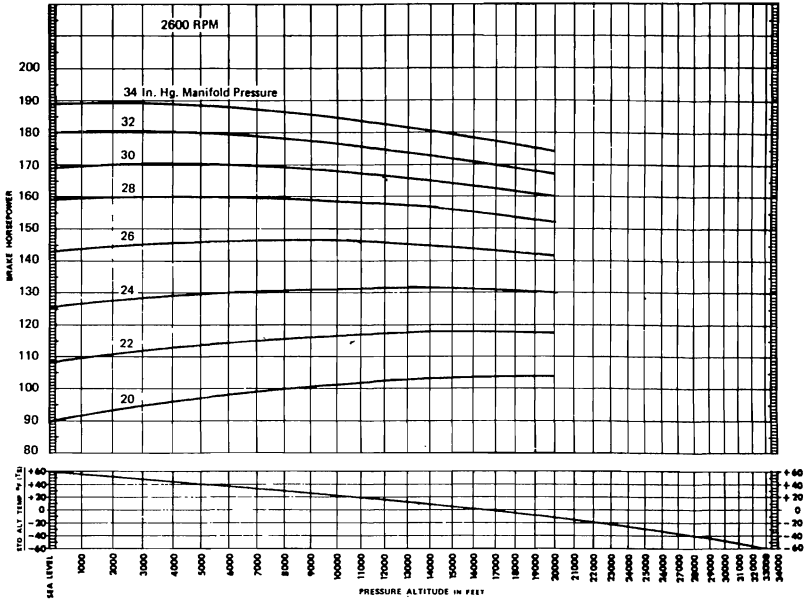

FIGURE 32
ALTITUDE PERFORMANCE AT 2600 RPM
TSIO-360-H, HB

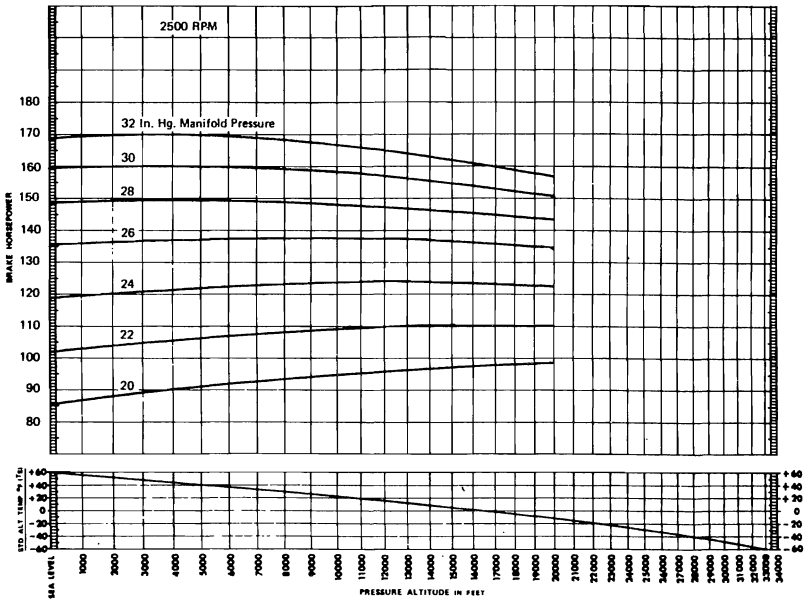
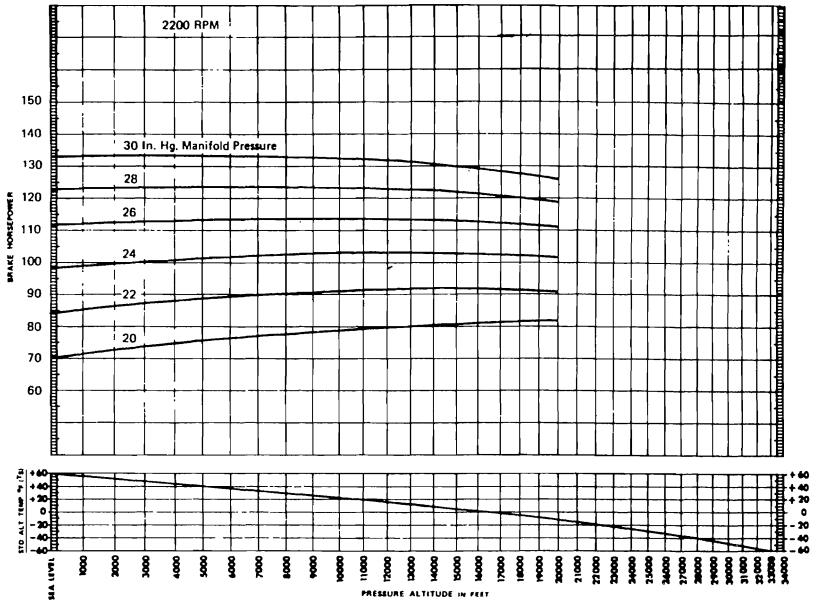

FIGURE 33
ALTITUDE PERFORMANCE AT 2500 RPM
TSIO-360-H, HB



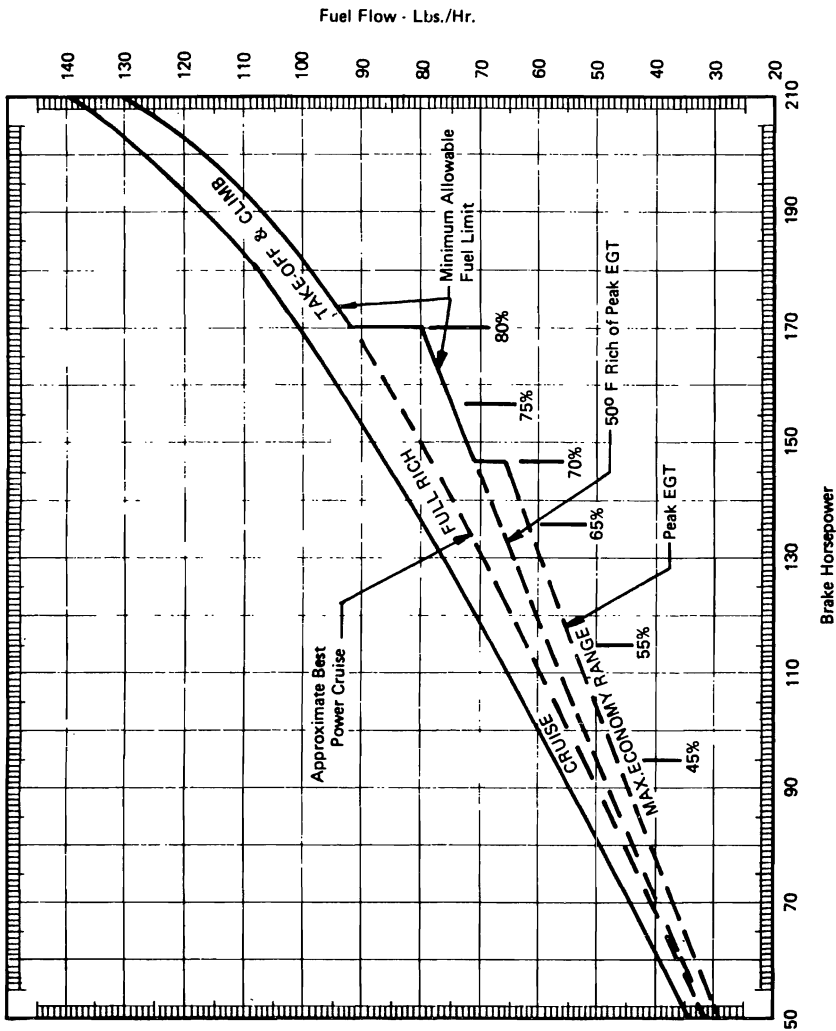

FIGURE 37
FUEL FLOW VS. BHP
TSIO-360-H, HB

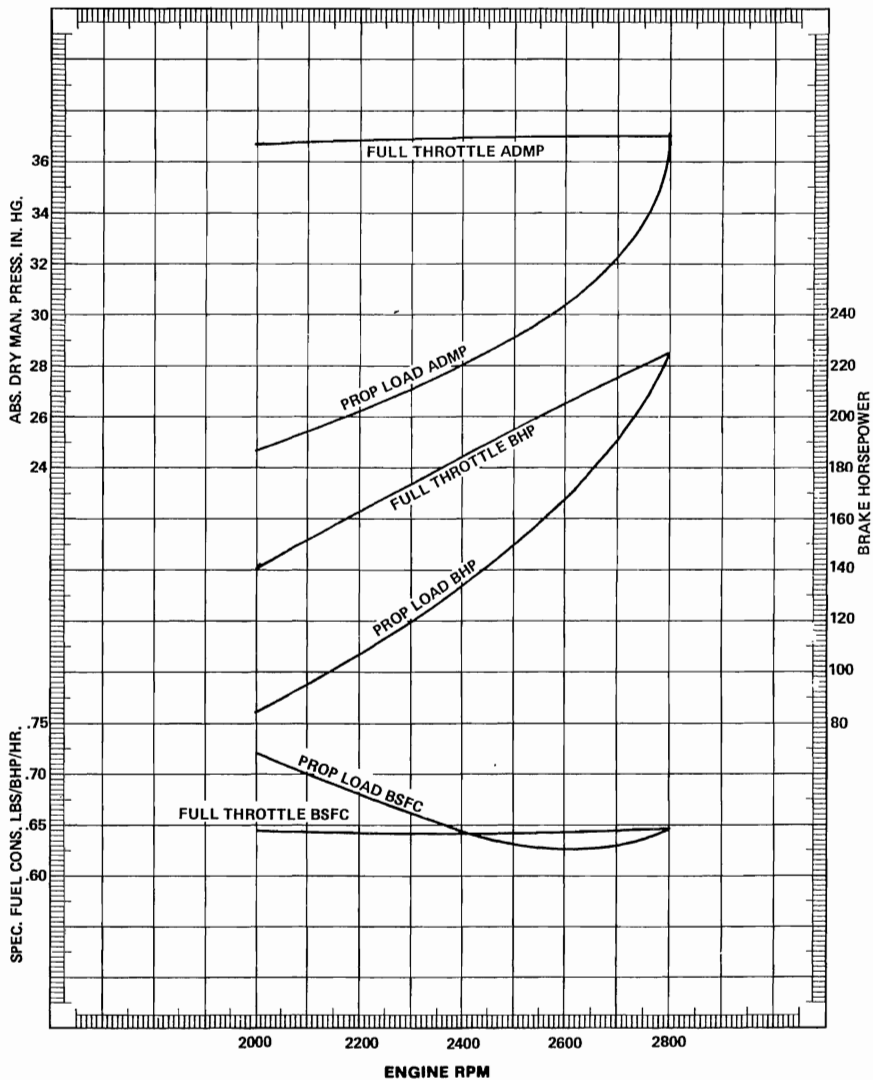

FIGURE 38
SEA LEVEL PERFORMANCE CURVES
TSIO-360-JB

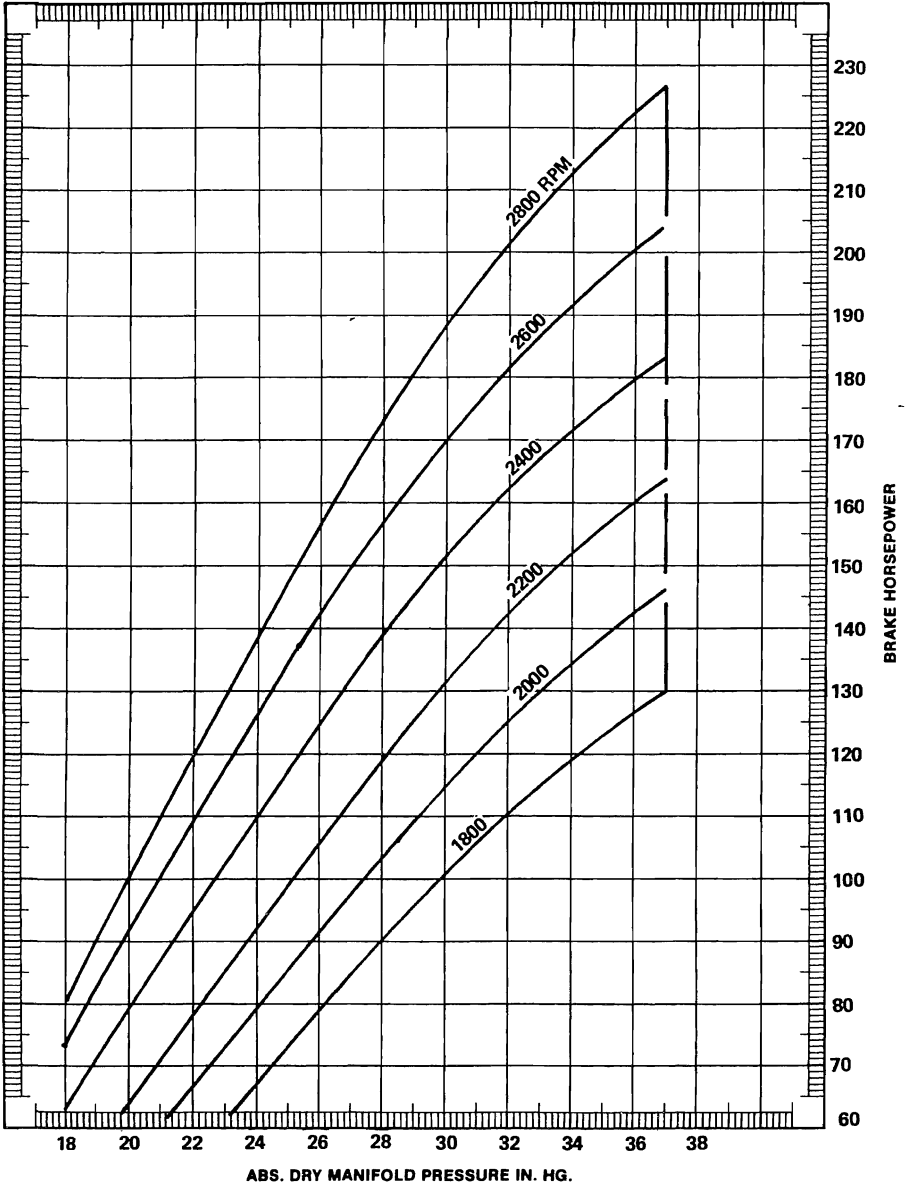

FIGURE 39
SEA LEVEL PERFORMANCE TO ALTITUDE
TSIO-360-JB

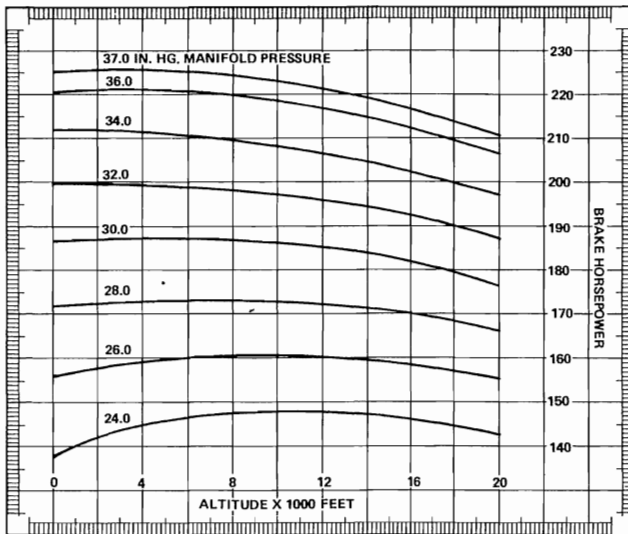

FIGURE 40
ALTITUDE PERFORMANCE AT 2800 RPM
TSIO-360-JB

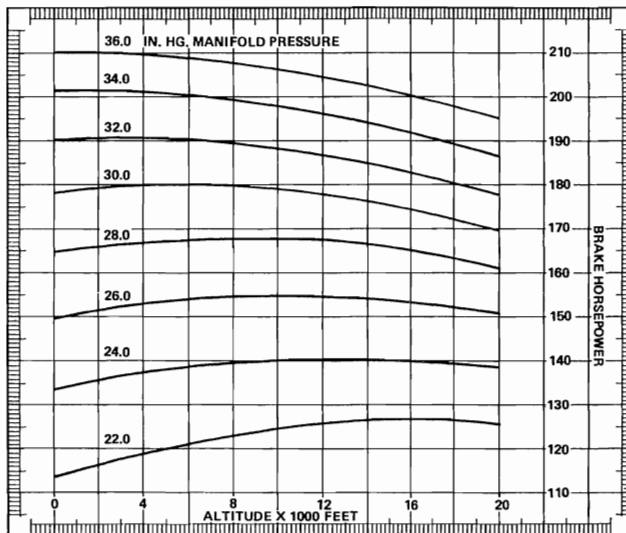

FIGURE 41
ALTITUDE PERFORMANCE AT 2700 RPM
TSIO-360-JB

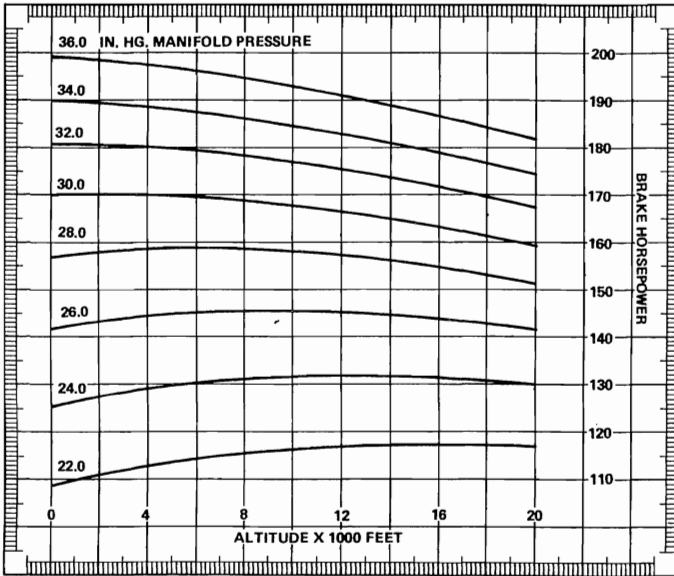

FIGURE 42
ALTITUDE PERFORMANCE AT 2600 RPM
TSIO-360-JB

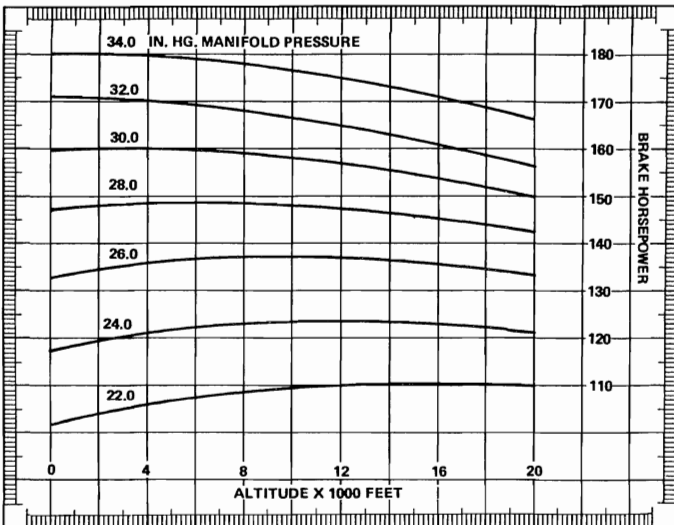

FIGURE 43
ALTITUDE PERFORMANCE AT 2500 RPM
TSIO-360-JB

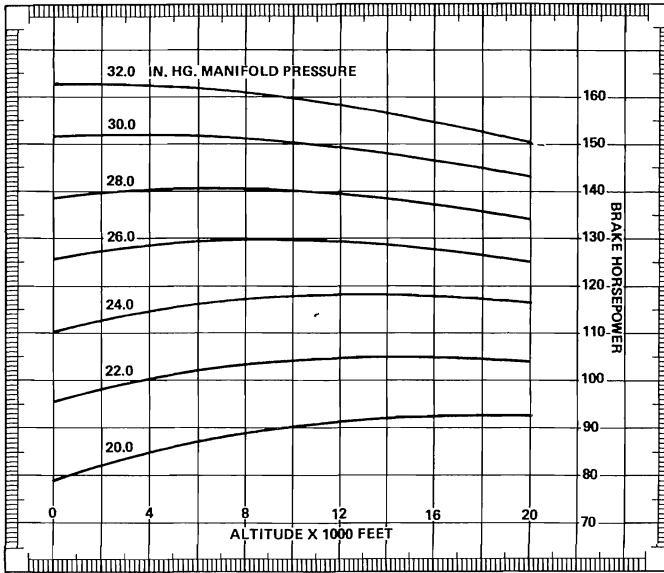

FIGURE 44
ALTITUDE PERFORMANCE AT 2400 RPM
TSIO-360-JB

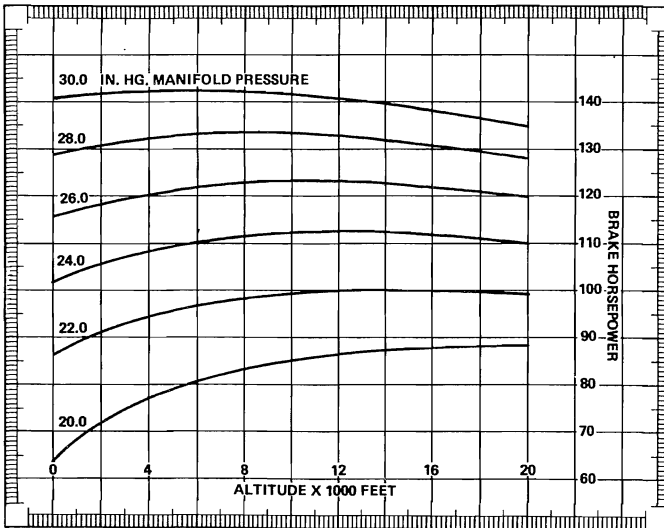

FIGURE 45
ALTITUDE PERFORMANCE AT 2300 RPM
TSIO-360-JB

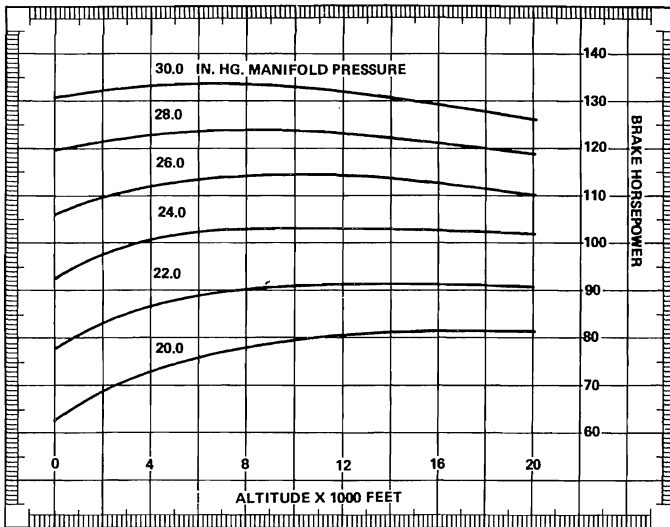
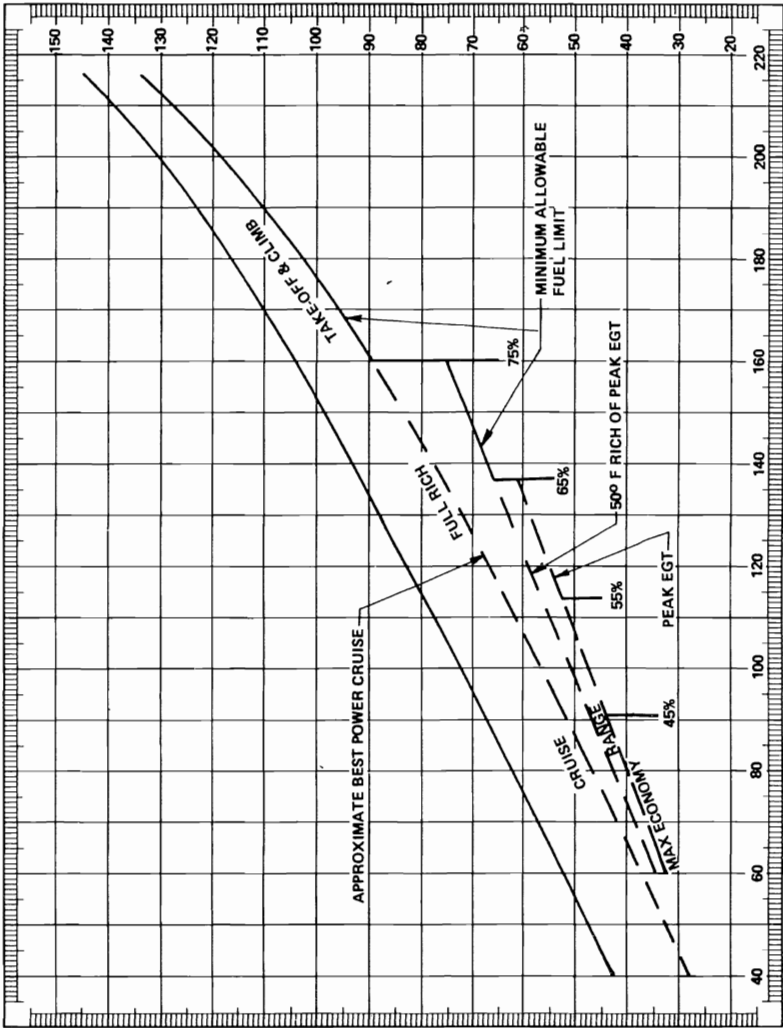

FIGURE 46
ALTITUDE PERFORMANCE AT 2200 RPM
TSIO-360-JB

Fuel Flow - Lbs./Hr.



Brake Horsepower

FIGURE 47
FUEL FLOW VS. BHP
TSIO-360-JB

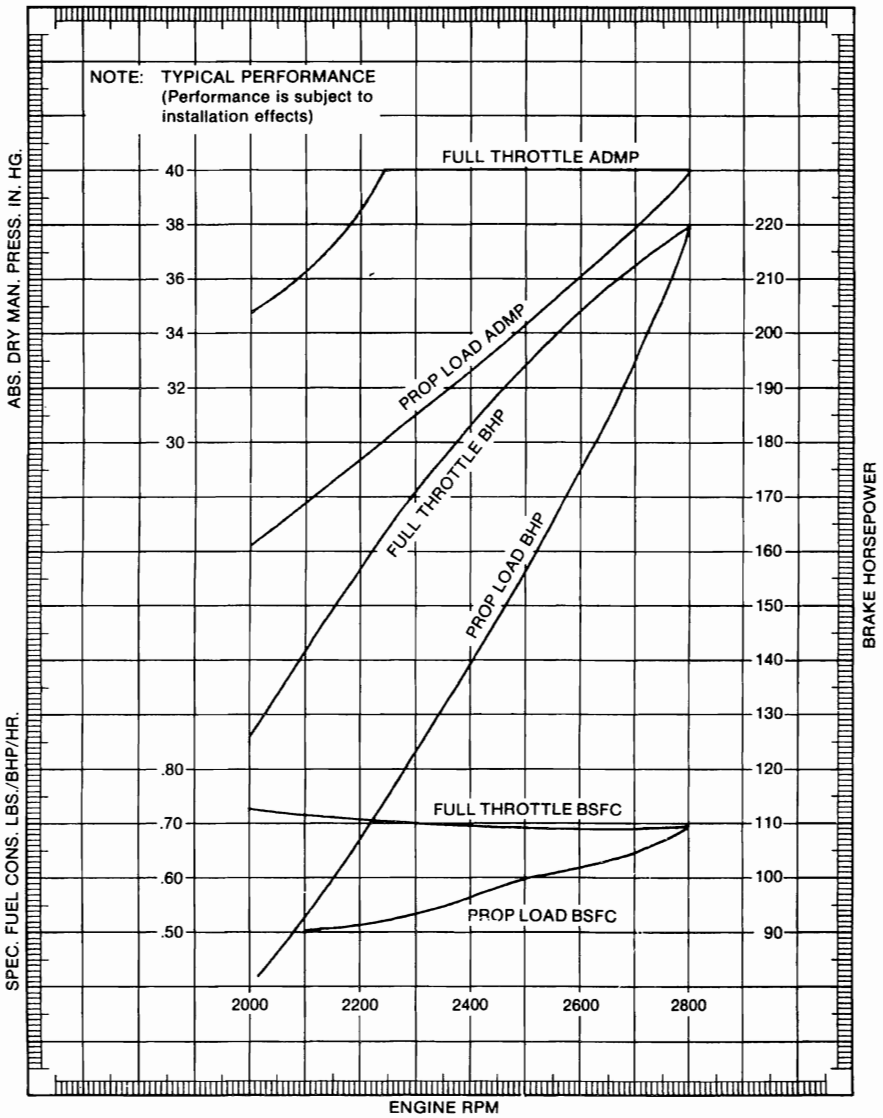

FIGURE 48
SEA LEVEL PERFORMANCE CURVES
L/TsIO-360-KB

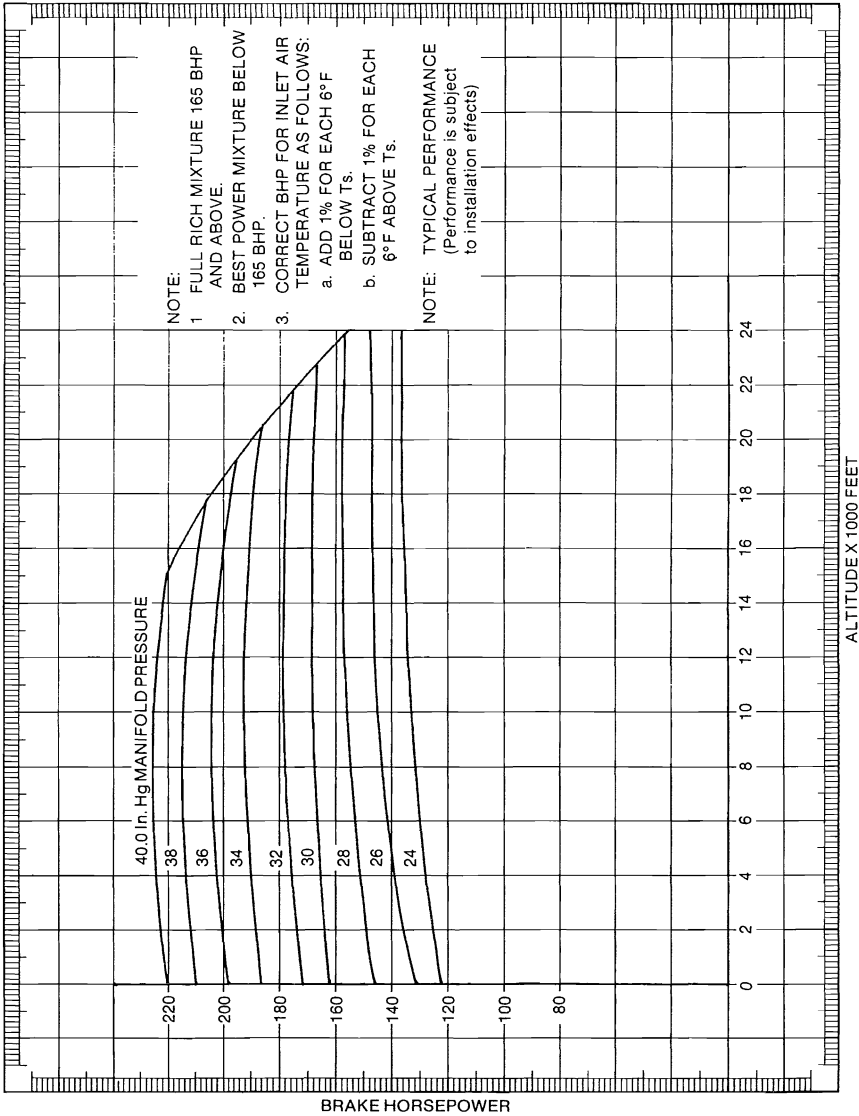

FIGURE 49
ALTITUDE PERFORMANCE
2800 RPM
L/TSIO-360-KB

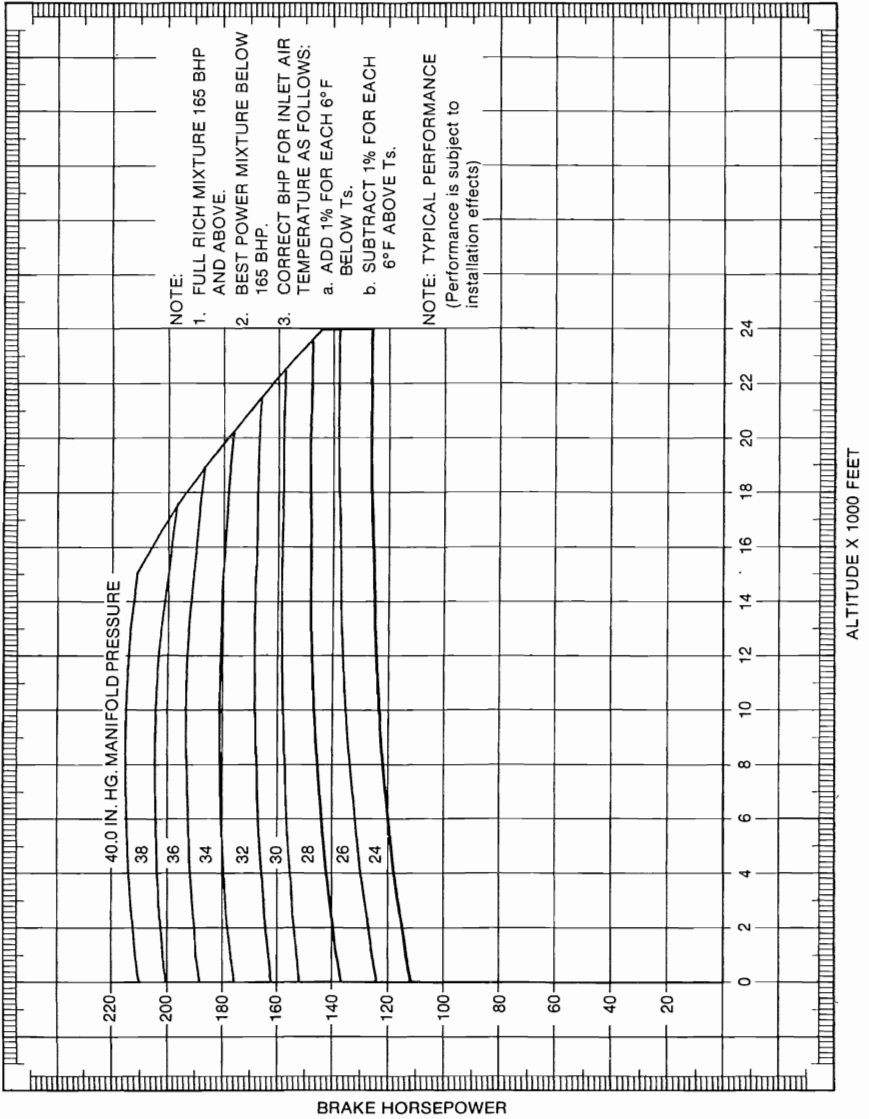

FIGURE 50
ALTITUDE PERFORMANCE
2700 RPM
L/TSIO-360-KB

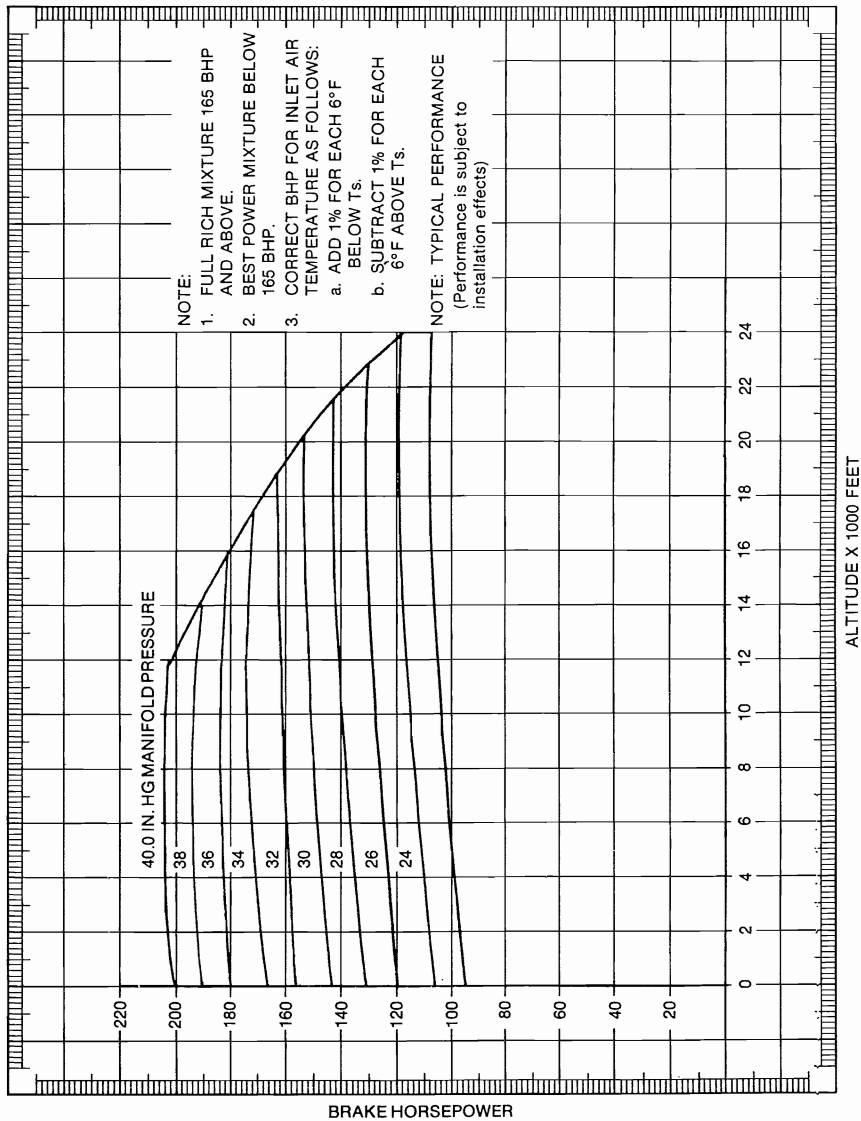

FIGURE 51
ALTITUDE PERFORMANCE
2600 RPM
L/TSIO-360-KB

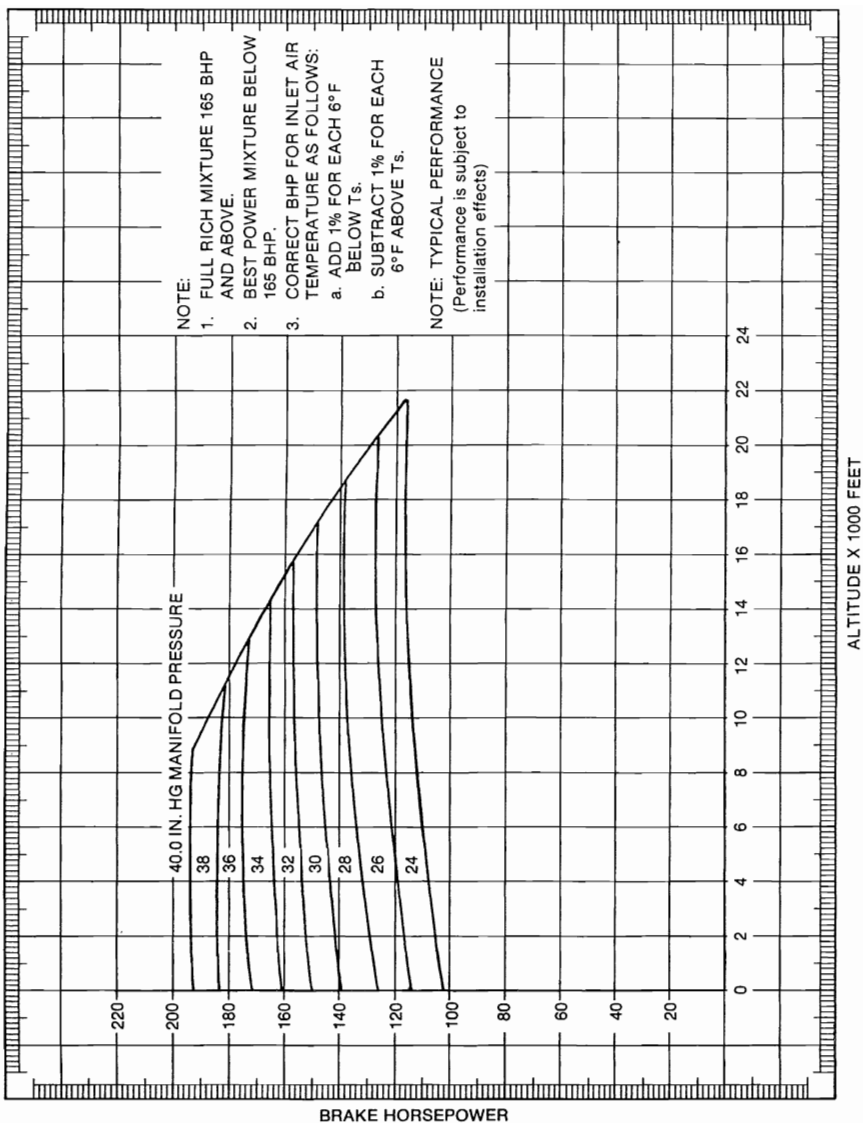

FIGURE 52
ALTITUDE PERFORMANCE
2500 RPM
L/TsIO-360-KB

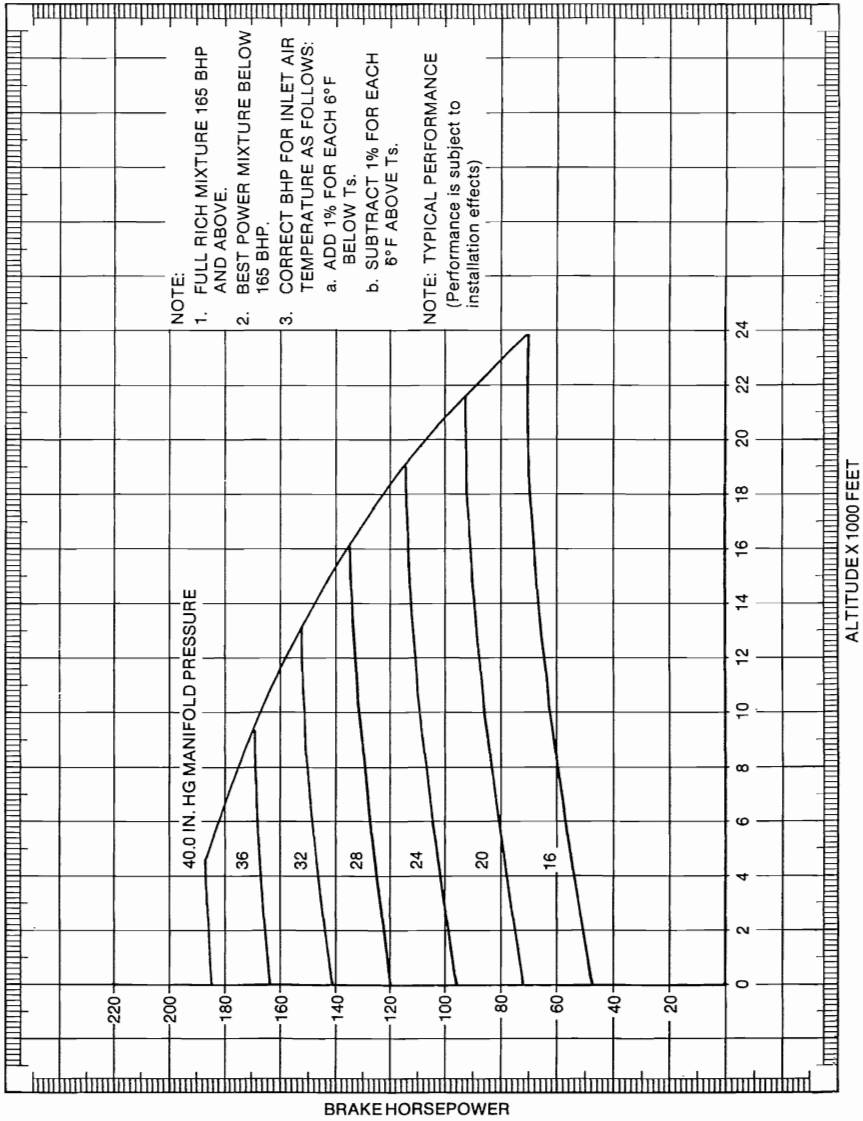
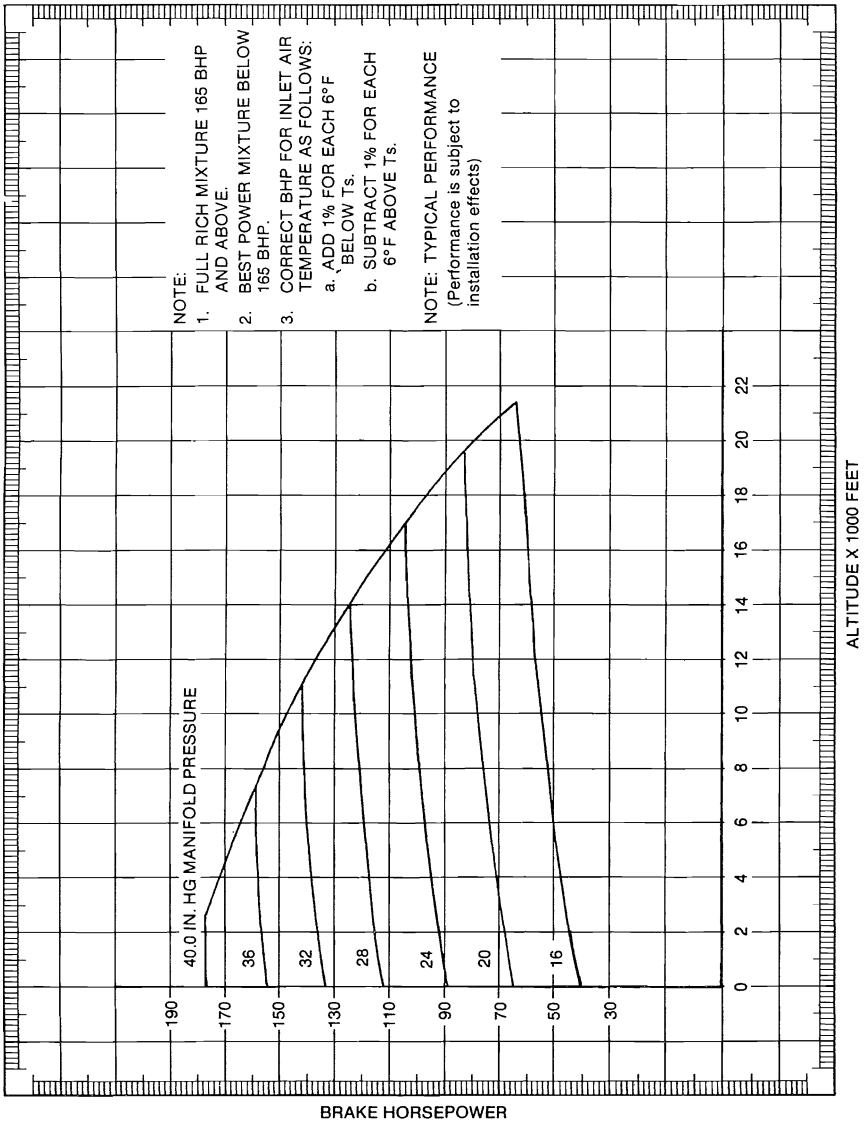

FIGURE 53
ALTITUDE PERFORMANCE
2400 RPM
L/TSIO-360-KB



**FIGURE 54
ALTITUDE PERFORMANCE
2300 RPM
L/TSIO-360-KB**

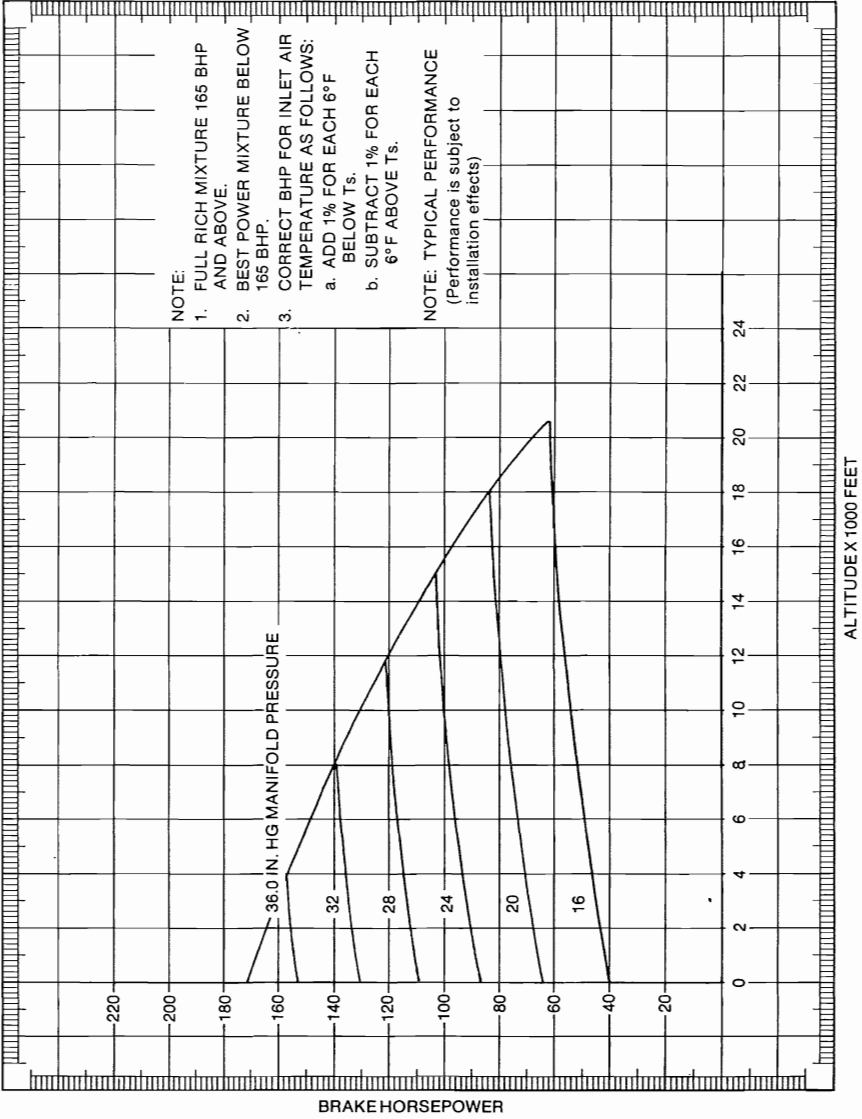

FIGURE 55
ALTITUDE PERFORMANCE
2200 RPM
L/TSIO-360-KB
5-51

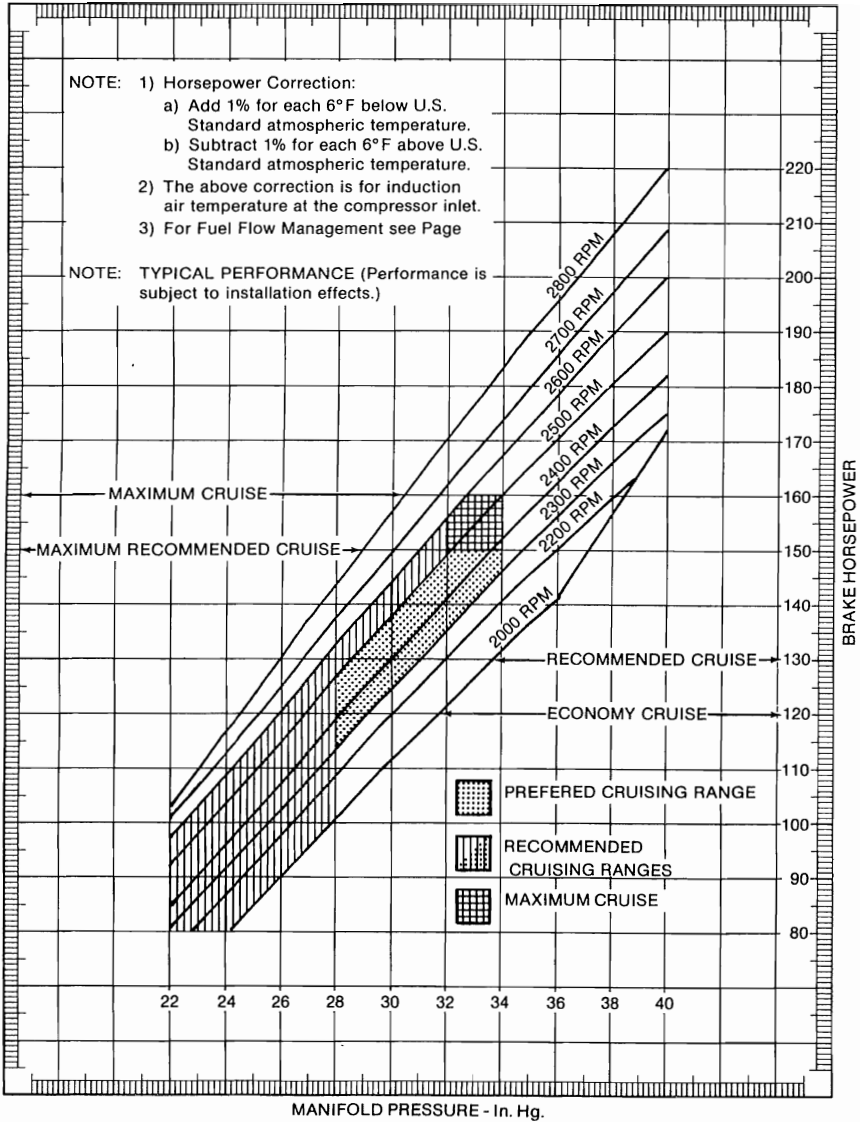

FIGURE 56
POWER MANAGEMENT OPERATING
RECOMMENDATIONS
L/TSIO-360-KB

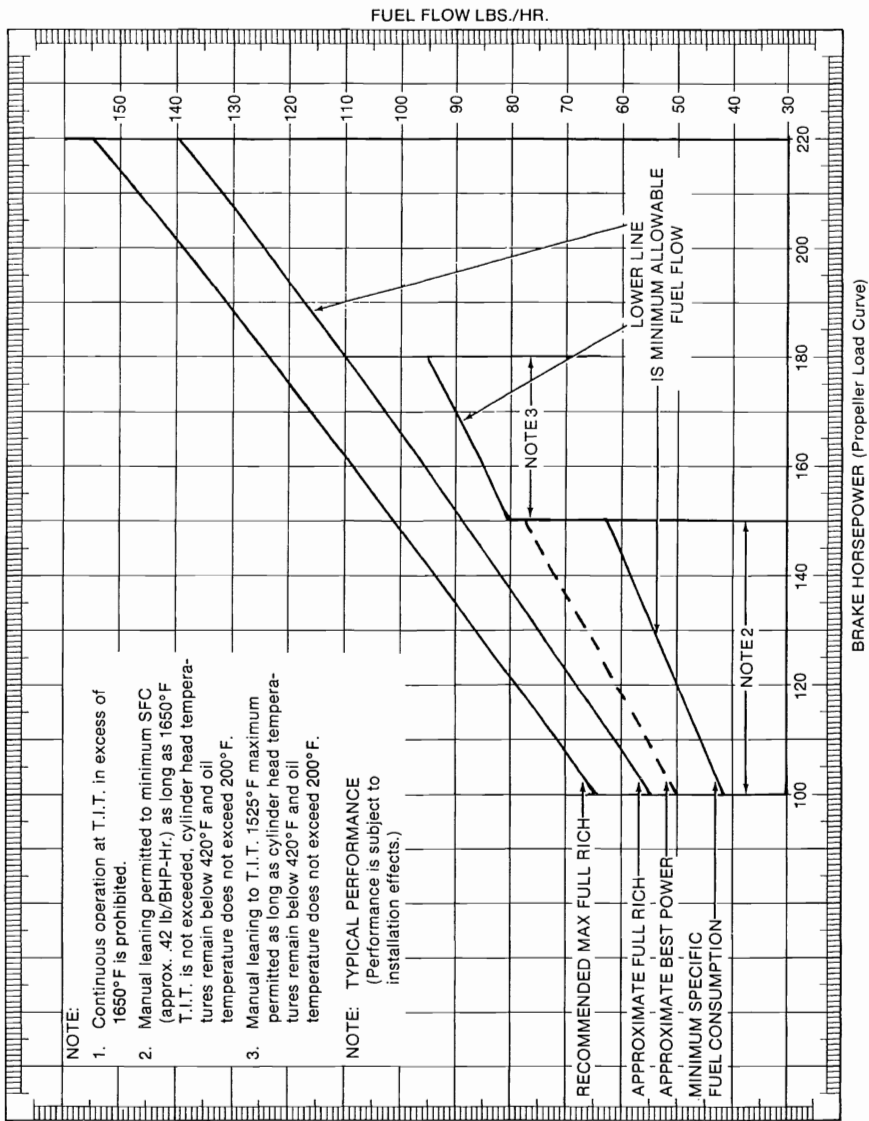

FIGURE 57
FUEL FLOW VS. BHP
L/TSIO-360-KB

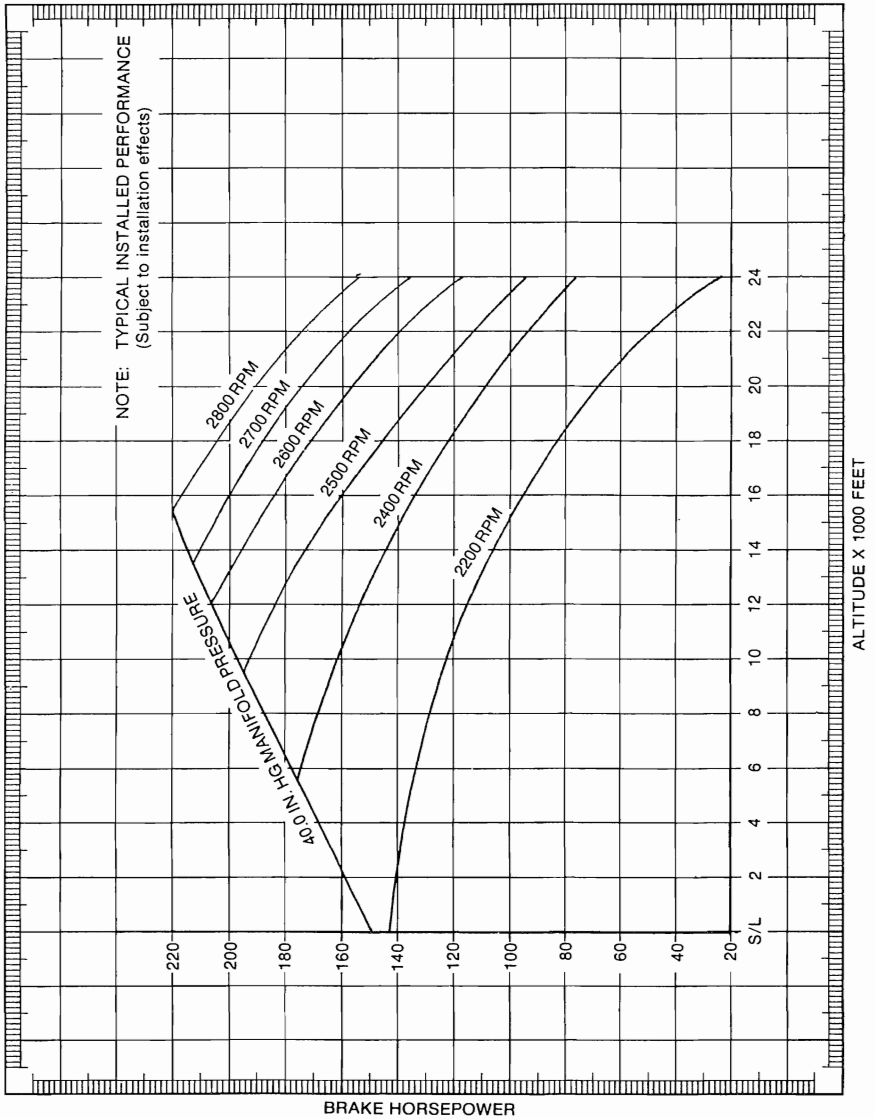

FIGURE 58
CRITICAL ALTITUDE VS. ENGINE SPEED
(STANDARD DAY)
L/TSIO-360-KB

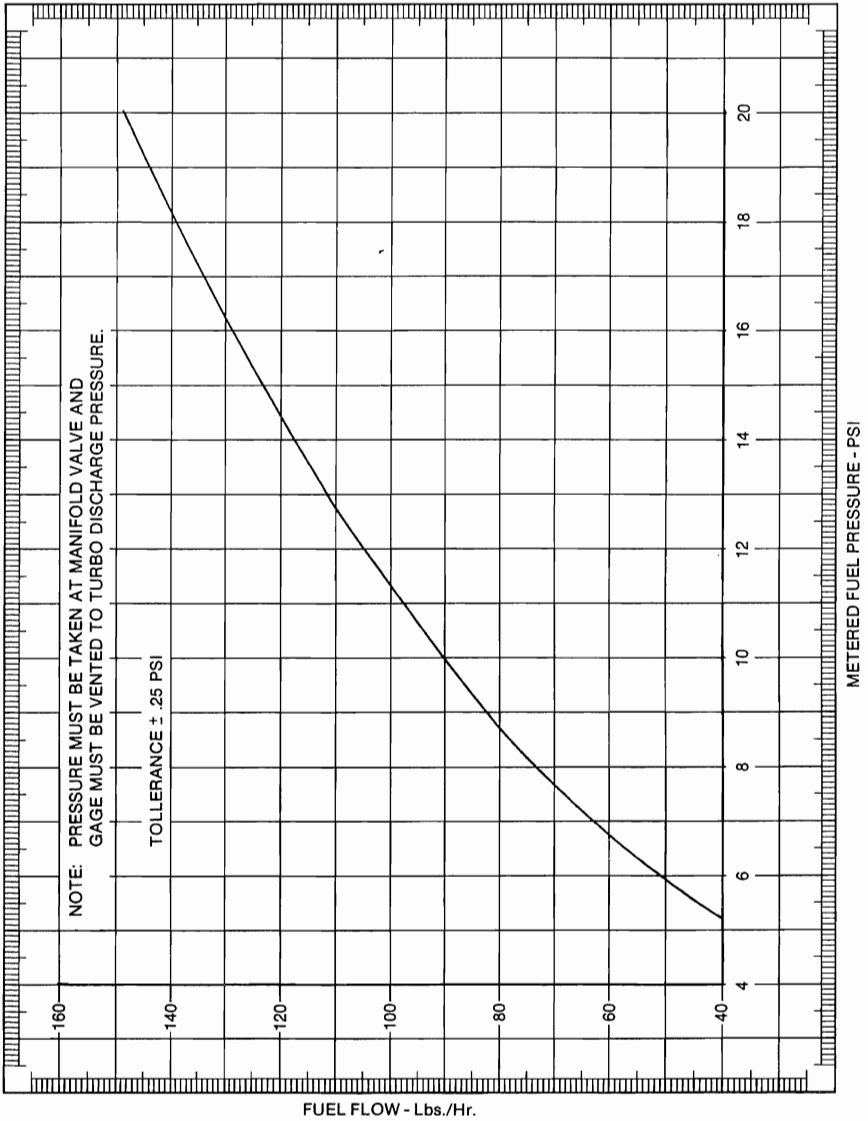

FIGURE 59
METERED FUEL PRESS. VS. FUEL FLOW
ALL MODELS

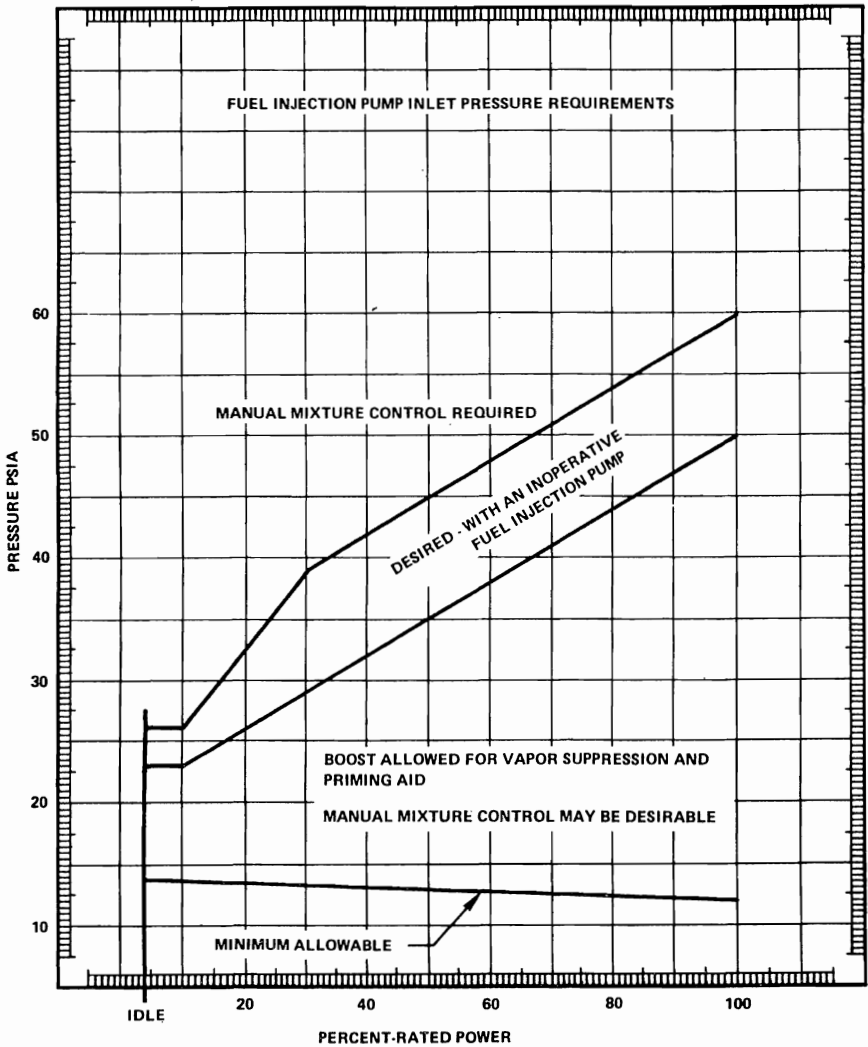

FIGURE 60
FUEL PUMP INLET PRESS. VS. % BHP
110° F AVGAS
TSIO-360-F, FB, GB, KB

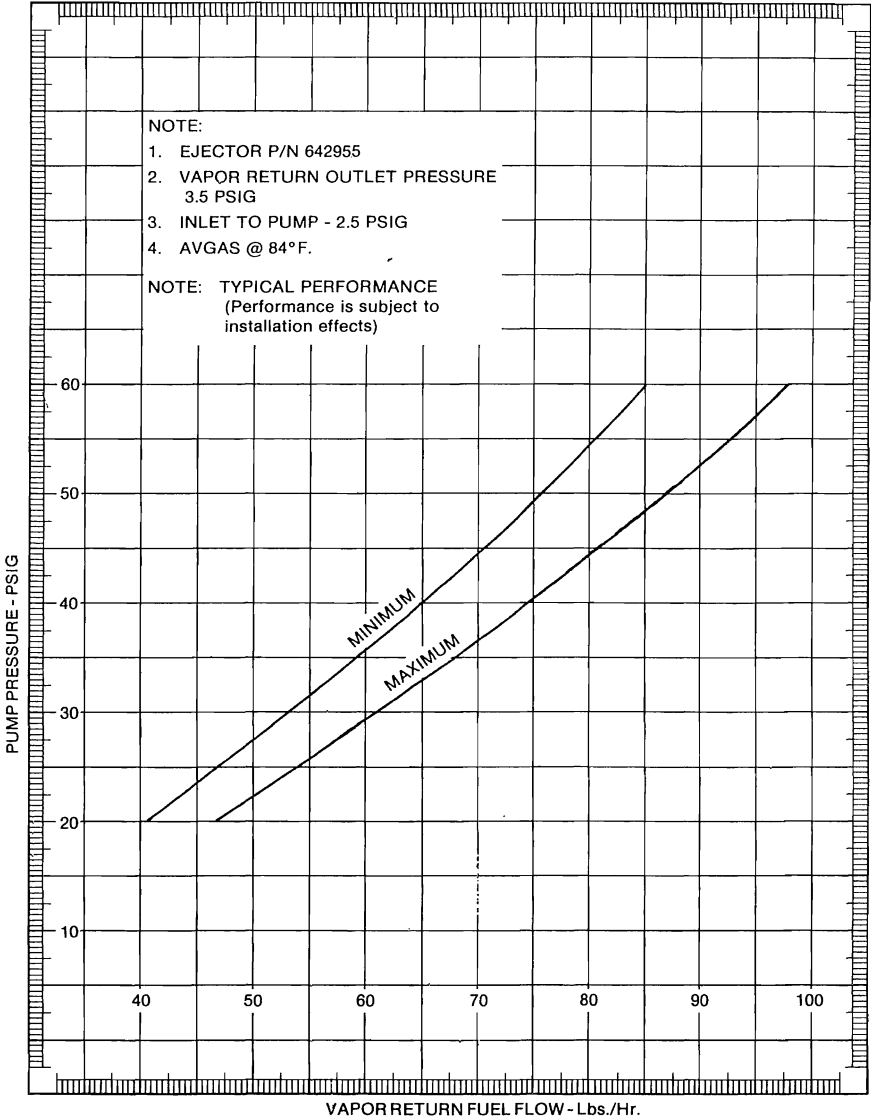

FIGURE 61
VAPOR RETURN FLOW VS. PUMP PRESSURE
TSIO-360-F, FB, GB, KB

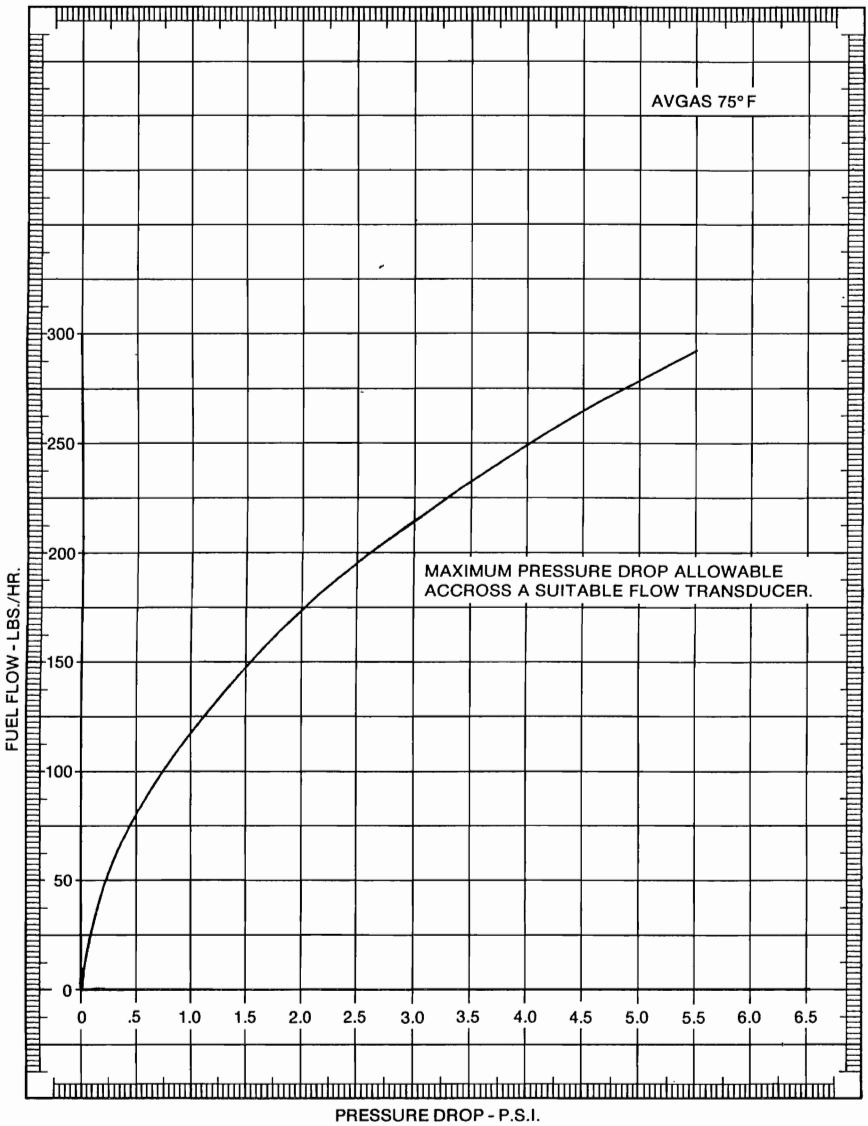

FIGURE 62
FUEL FLOW VS. PRESSURE DROP
TSIO-360-GB, KB
 5-58

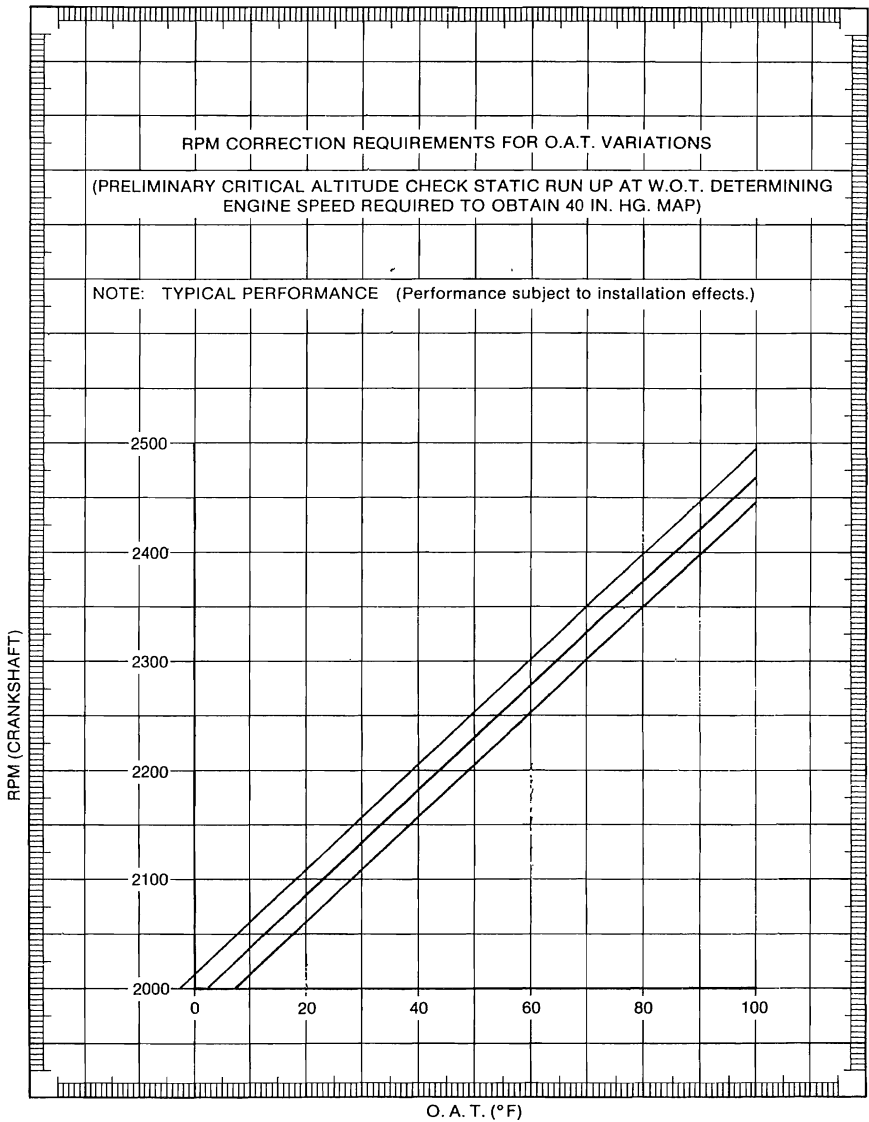

FIGURE 63
SPEED CORRECTION CHART
S/L TO 2000 FT. MSL
TSIO-360-F, FB, GB, KB

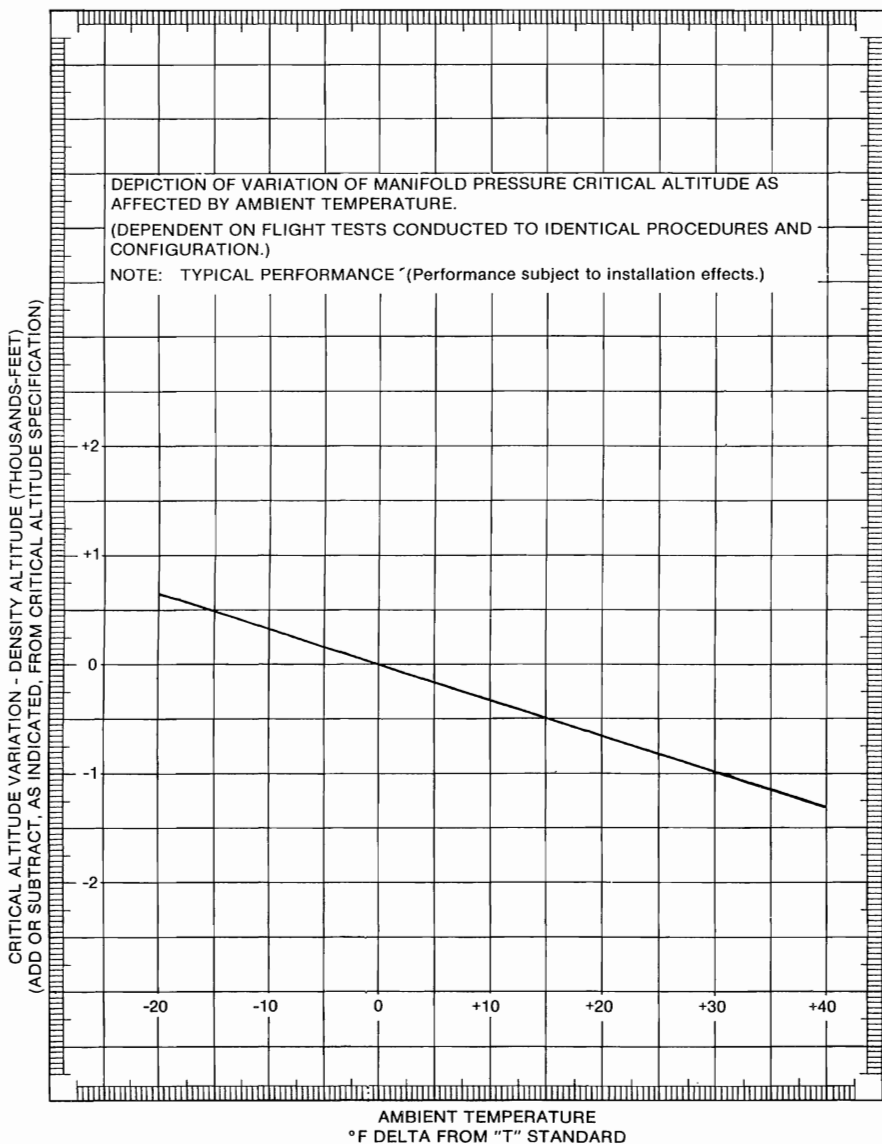

FIGURE 64
CRITICAL ALTITUDE VARIATIONS
(TYPICAL) SIMPLE TURBO SYSTEMS
TSIO-360-F, FB, GB, KB

BASED ON SET UP AND FLIGHT TEST PROCEDURES SAME AS PIPER PPS.
 * DENSITY ALTITUDE TO BE MEASURED AT THE TURBOCHARGER COMPRESSOR INLET.
 WHEN ENCOUNTERED CONDITIONS OF EXCESS VAPOR INGESTION BOOST PUMP
 OPERATION MAY BE REQUIRED TO STAY RICHER THAN LEAN LIMIT SHOWN.
 NOTE: TYPICAL PERFORMANCE (Performance subject to installation effects.)

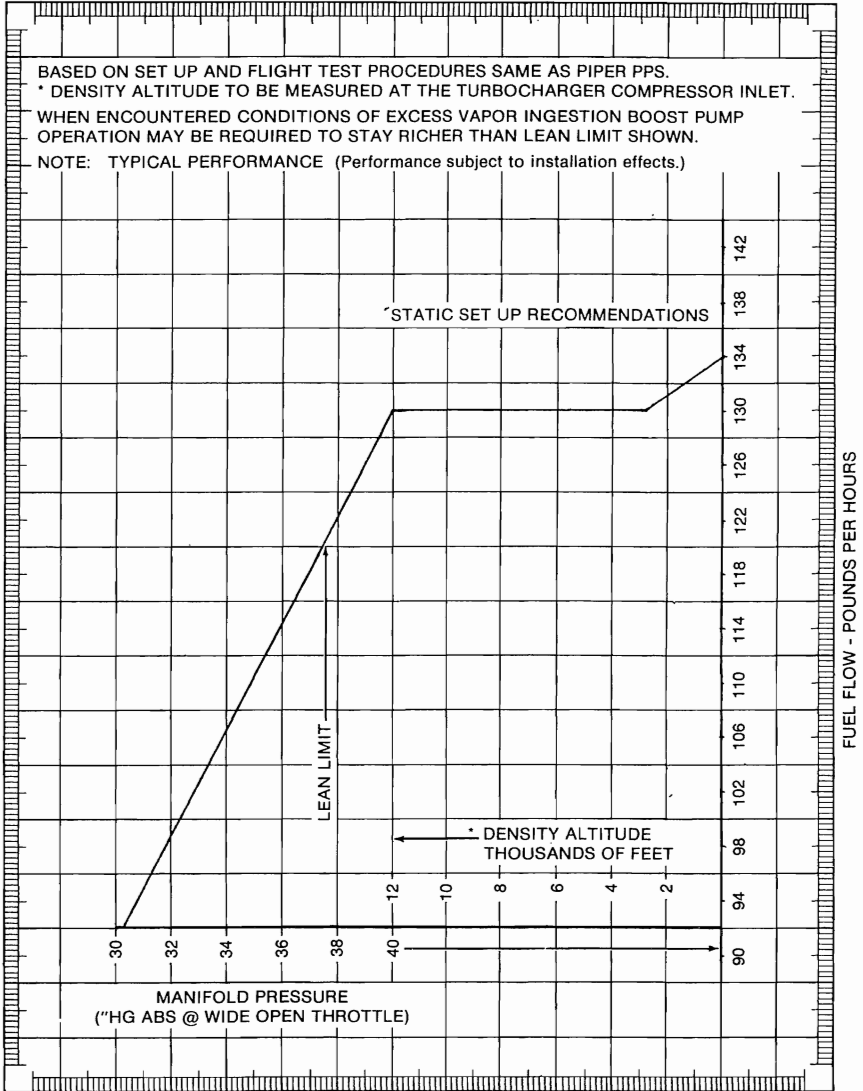

FIGURE 65
TYPICAL ENGINE FUEL SYSTEM
OPERATING CHARACTERISTICS
2600 RPM (STANDARD DAY AT S/L)

SECTION VI

ABNORMAL ENVIRONMENTAL CONDITIONS

The following adverse conditions should be given special attention. They are: Cold Weather Operation, Hot Weather Operation and High Altitude Ground Operation. The information that follows may be helpful to the operator in obtaining satisfactory engine performance while operating in these conditions.

COLD WEATHER OPERATION (Ambient Temperature Below Freezing)

NOTE . . . Prior to operation and/or storage in cold weather, assure engine oil viscosity is SAE 30 or SAE 10W30. In the event of temporary cold weather operation, not justifying an oil change, consideration should be given to hanging the aircraft between flights.

Engine starting during extremely cold weather is generally more difficult than during temperate conditions. Cold soaking causes the oil to become heavier (more viscous), making it more difficult for the battery to turn the engine over. This results in a slow cranking speed and an abnormal drain on the battery capacity. At low temperatures, gasoline does not vaporize readily, further complicating the starting problem.

False starting (failure to continue running after starting) often results in the formation of moisture on the spark plugs due to condensation. This moisture can freeze and must be eliminated, either by applying heat to the engine or removing and cleaning the plugs.

Preheating

The use of preheat and auxiliary power (battery cart) will facilitate starting during cold weather. This procedure is recommended anytime the temperature falls below 30° F. and the aircraft has been cold soaked in excess of two hours. Successful starts without these aids can be expected at temperatures below normal, provided the aircraft battery is in good condition and the ignition and fuel systems are properly maintained.

The following procedures are recommended for preheating, starting, warm-up, run-up and takeoff.

1. Select a high volume hot air heater. Small electric heaters which are inserted into cowling "bug eye" do not appreciably warm the oil and may result in superficial preheating.

WARNING . . . Superficial application of preheat to a cold-soaked engine can have disastrous results.

A minimum of preheat application may warm the engine enough to permit starting but will not de-congeal oil in the sump, lines, cooler, filter, etc. Typically, heat is applied to the upper portion of the engine for a few minutes after which the engine is started and normal operation is commenced. The operator may be given a false sense of security by indications of oil and cylinder temperatures as a result of preheat. Extremely hot air flowing over the cylinders and oil temperature thermocouples may lead one to believe the engine is quite warm; however, oil in the sump and filter are relatively remote and will not warm as rapidly as a cylinder, for example, even when heat is applied directly.

Oil lines are usually "lagged" with material which does an excellent job of insulating. Congealed oil in such lines may require considerable preheat. The engine may start and apparently run satisfactorily, but can be damaged from lack of lubrication due to congealed oil in various parts of the system. The amount of damage will vary and may not become evident for many hours. On the other hand, the engine may be severely damaged and could fail shortly following application of high power. Improper or insufficient application of preheat and the resulting oil and cylinder temperature indications may encourage the pilot to expedite his ground operation and commence a takeoff prematurely. This procedure only compounds an already bad situation.

Proper procedures require thorough application of preheat to all parts of the engine. Hot air should be applied directly to the oil sump and external oil lines as well as the cylinders, air intake and oil cooler. Excessively hot air can damage non-metallic components such as seals, hoses and drive belts. Do not attempt to hasten the preheat process.

Before starting is attempted, turn the engine by hand or starter until it rotates freely. After starting, observe carefully for high or low oil pressure and continue the warm-up until the engine operates smoothly and all controls can be moved freely. Do not close the cowl flaps to facilitate warm-up as hot spots may develop and damage ignition wiring and other components.

2. Hot air should be applied primarily to the oil sump and filter area. The oil drain plug door or panel may provide access to these areas. Continue to apply heat for 15 to 30 minutes and turn the propeller, by hand, through 6 or 8 revolutions at 5 or 10 minute intervals.

3. Periodically feel the top of the engine and, when some warmth is noted, apply heat directly to the upper portion of the engine for approximately five minutes. This will provide sufficient heating of the cylinders and fuel lines to promote better vaporization for starting. If enough heater hoses are available, continue heating the sump area. Otherwise, it will suffice to transfer the source of heat from the sump to the upper part of the engine.

4. Start the engine immediately after completion of the preheating process. Since the engine temperature will be above 32°F., use the normal starting procedure.

NOTE . . . Since the oil in the oil pressure gauge line may be congealed, as much as 60 seconds may elapse before oil pressure is indicated. If oil pressure is not indicated within one minute, shut the engine down and determine the cause.

5. Operate the engine at 1000 RPM until some oil temperature is indicated. Monitor oil pressure closely during this time and be alert for a sudden increase or decrease. Retard throttles, if necessary, to maintain oil pressure below 100 p.s.i. If oil pressure drops suddenly to less than 30 p.s.i., shut down the engine and inspect the lubrication system. If no damage or leaks are noted, preheat the engine for an additional 10 to 15 minutes before restarting.

6. Before takeoff, run up the engine to 1700 RPM. If necessary, approach this RPM in increments to prevent oil pressure from exceeding 100 PSI. At 1700 RPM, adjust the propeller control to "Full Decrease RPM" until minimum governing RPM is observed, then return the control to "Full Increase RPM". Repeat this procedure three or four times to circulate warm oil into the propeller dome. If the aircraft manufacturer recommends checking the propeller feathering system, move the control to the "Feather" position but do not allow the RPM to drop more than 300 below minimum governing speed.

NOTE . . . Continually monitor oil pressure during run-up.

7. Check magnetos in the normal manner.

8. When the oil temperature has reached 100° F. and oil pressure does not exceed 80 PSI at 1700 RPM, the engine has been warmed sufficiently to accept full rated power.

CAUTION . . . Do not close cowl flaps in an attempt to hasten engine warm-up.

NOTE . . . Fuel flow will likely be on the high limit; however, this is normal and desirable since the engine will be developing more horsepower at substandard ambient temperatures.

If preheat is not used, employ the following start procedures:

1. Fuel Selector - Main tank or as instructed by aircraft manufacturer.
2. Battery Switch - On.
3. Mixture - Rich.
4. Throttle - Open.
5. Primer - Operate until fuel flow or fuel pressure shows maximum reading.

6. Throttle - Positioned to approximate 1000-1200 RPM position.
7. Starter - Engage.
8. Primer - Operate as necessary to initiate firing. Continue to prime as necessary to sustain engine operation.
9. Throttle - Gradually retard to 800-1000 RPM for warm-up.

Observe oil pressure for indication and warm-up engine at 1000 RPM. Ground operation and run-up require no special techniques other than warming the engine sufficiently to maintain oil temperature and oil pressure within limits when full RPM is applied.

NOTE . . . Before applying power for takeoff, check that oil pressure, oil temperature and cylinder temperature are well within the normal operating range. When full power is applied for takeoff, insure that oil pressure is within limits and steady. Surging or overshooting of manifold pressure, RPM or fuel flow may indicate the engine is not satisfactorily warmed up.

CAUTION . . . Any of the following engine reactions should be cause for concern, and are justification for aborting the takeoff.

- a. Excessive manifold pressure other than momentary over-boost of 1 or 2 inches.
- b. Low, high or surging RPM.
- c. Fuel Flow excessively high or low.
- d. Any oil pressure indication other than steady and within limits.
- e. Engine roughness.

HOT WEATHER OPERATION

(Ambient Temperature in Excess of 90°F.)

CAUTION . . . When operating in hot weather areas, be alert for higher than normal levels of dust, dirt or sand in the air. Inspect air filters frequently and be prepared to clean or replace them if necessary. Weather conditions can lift damaging levels of dust and sand high above the ground. In the event the aircraft should be flown through such conditions, an oil change is recommended as soon as is practical. Do not intentionally operate the engines in dust and/or sand storms. The use of dust covers on the cowling will afford additional protection for a parked aircraft.

In-flight operation during hot weather usually presents no problem since ambient temperatures at flight altitudes are seldom high enough to overcome the cooling system used in modern aircraft design. There are, however, three areas of hot weather operation which will require special attention on the part of the operator. These are: Starting a hot engine, Ground operation under high ambient temperature conditions and Takeoff and initial climbout.

Engine Heat Soaking

After an engine is shutdown, the temperature of its various components will begin to stabilize; that is, the hotter parts such as cylinders and oil will cool, while other parts will begin to heat up due to lack of air flow, heat conduction, and heat radiation from those parts of the engine which are cooling. At some time period following engine shutdown, the entire unit will stabilize near the ambient temperature. This time period will be determined by temperature and wind conditions and may be as much as several hours. This heat soaking is generally at the worst from 30 minutes to one hour following shutdown. During this time, the fuel system will heat up causing the fuel in the pump and lines to "boil" or vaporize. During subsequent starting attempts, the fuel pump will initially be pumping some combination of fuel and fuel vapor. At the same time, the injection nozzle lines will be filled with varying amounts of fuel and vapor. Until the entire fuel system becomes filled with liquid fuel, difficult starting and unstable engine operation may be experienced.

Another variable affecting this fuel vapor condition is the state of the fuel itself. Fresh fuel contains a concentration of volatile ingredients. The higher this concentration is, the more readily the fuel will vaporize and the more severe will be the problems associated with vapor in the fuel system. Time, heat or exposure to altitude will "age" aviation gasoline; that is, these volatile ingredients tend to dissipate. This reduces the tendency of fuel to vaporize and, up to a point, will result in reduced starting problems associated with fuel vapor. If the volatile condition reaches a low enough level, starting may become difficult due to poor vaporization at the fuel nozzles, since the fuel must vaporize in order to combine with oxygen in the combustion process.

The operator, by being cognizant of these conditions, can take certain steps to cope with problems associated with hot weather/hot engine starting. The primary objective should be that of permitting the system to cool. Low power settings during the landing approach will allow some cooling prior to the next start attempt. Ground operation tends to heat up the engine, therefore minimizing this will be beneficial. Cowl flaps should be opened fully while taxiing. The aircraft should be parked so as to face into the wind to take advantage of the cooling effect. If restarting is attempted in less than an hour following shutdown, vapor lock may be experienced.

Normal starting procedure should be used except that the throttle should be opened more while cranking. Under extreme temperature conditions, the "Hot Start Procedure" in Section III should be employed.

Ground Operation Under High Ambient Temperature Conditions.

Oil and cylinder temperatures should be monitored closely during taxiing and engine run-up. Operate with cowl flaps full open. Do not operate the engines at high RPM except for necessary pre-flight checks. If takeoff is not to be made immediately following engine run-up, the aircraft should be faced into the wind and the engine idled at 900-1000 RPM. It may be desirable to operate the fuel boost pumps to assist in suppressing fuel vapor and provide more stable fuel pressure during taxiing and engine run-up.

Takeoff and Initial Climbout. Use rated power for take-off and establish the climb configuration recommended by the aircraft manufacturer. Temperatures should be closely monitored and climb altitude and sufficient airspeed may be used to provide adequate cooling of the engine.

GROUND OPERATION AT HIGH ALTITUDE AIRPORTS

Idle fuel mixture will be rich at high density altitudes. Under extreme conditions it may be necessary to manually lean the mixture in order to sustain engine operation at low RPM. When practical, operate the engines at higher idling speed.

CAUTION . . . Mixture Full Rich for takeoff and/or in accordance with aircraft manufacturer's Pilot Operator's Handbook.

SECTION VII

ENGINE DESCRIPTION

The designation TSIO-360-(Letter) (Number) describes this engine as follows:

- TS: Denotes "turbosupercharged".
- I: Denotes "fuel injected".
- O: Denotes "opposed", and refers to the horizontally opposed cylinder arrangement.
- 360: Denotes piston displacement in cubic inches.
- Letter: Denotes "specific engine model and configuration".
- Number: Denotes "specification number" (Refer Manual X30508)

The engine runs clockwise, (normal rotation) as viewed from the accessory case (rear). Those engines designated with the prefix "L", ie. LTSIO-360, rotation is counterclockwise.

LUBRICATION SYSTEM.

The oil supply is contained in an 8-quart, wet sump attached to the bottom of the crankcase. A conventional dipstick is provided for determining the oil quantity.

When the crankshaft is turning, oil is drawn through a screen and pick-up tube which extends from the sump to a port in the crankcase. It then passes to the inlet of the gear-type, engine-driven oil pump and is forced under pressure through the pump outlet. A pressure relief valve prevents excessive oil pressure by allowing excess oil to be returned to the sump. After exiting the pump, the oil (now under pressure), enters a full-flow filter and is passed on to the oil cooler. If the filter element becomes blocked, a bypass relief valve will open to permit unfiltered oil to flow to the engine. As the oil enters the oil cooler, it will flow in one of two directions:

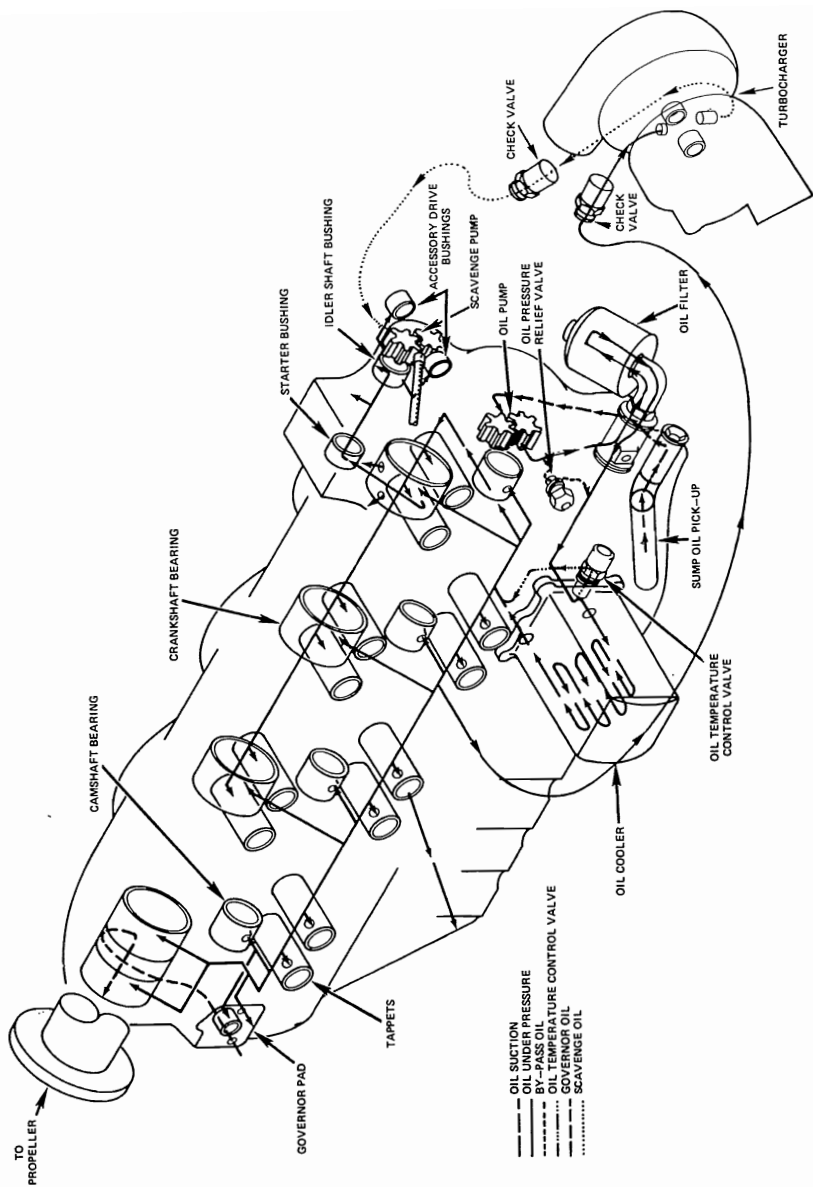

FIGURE 66
OIL LUBRICATION DIAGRAM

- (a) When the oil is cold, an oil temperature control unit will open and most of the oil will bypass the cooler. Some oil always flows through the cooler to help prevent congealing in cold weather.
- (b) As the oil warms, the oil temperature control unit actuates to close off the cooler bypass forcing the oil to flow through the cooler core. In operation, the oil temperature control unit modulates to maintain oil temperature in the normal range of approximately 170°F.

After leaving the cooler, the oil enters the crankcase where the various channels and passageways direct it to the bearing surfaces and other areas requiring lubrication and cooling. The propeller governor boosts engine oil pressure for operation of the propeller. It controls oil pressure going to the propeller hub to maintain or change propeller blade angles. This oil flows through the propeller shaft to reach the hub.

Other areas within the engine receiving oil include the valve lifters, inner piston domes and lower cylinder walls. A tap supplies oil pressure for lubrication of the turbocharger through an external line. After lubricating the turbocharger bearings, it is drawn into a scavenge pump and returned to the oil sump. Oil within the engine drains, by gravity, back into the sump.

FUEL SYSTEM.

The fuel injection system is of the multi-nozzle, continuous-flow type which controls fuel flow to match engine requirements (Figure 68). Any change in air throttle position, engine speed, deck pressure, or a combination of these causes changes in fuel pressure in the correct relation to the engine requirements. A manual mixture control, and an airframe supplied fuel flow gauge indicating metered fuel flow are provided for precise leaning at any combination of altitude and power setting. As fuel flow is directly proportional to metered fuel pressure, settings can be predetermined and fuel consumption can be accurately predicted and controlled.

The continuous-flow system permits the use of a typical rotary vane pump with integral relief valve. With this system there is no need for an intricate mechanism for timing injection to the engine.

The fuel injector pump is equipped with a vapor separator where vapor is separated by a swirling action and returned to the fuel tank in a liquid form. The fuel injector pump creates a flow and directs the liquid fuel into the metering unit assembly.

The fuel metering unit/air throttle controls the amount of air admitted into the intake manifold and meters the proportionate amount of fuel to the fuel manifold valve. The assembly has two control units; one for air in the air throttle assembly, and one for the fuel control unit.

The manifold valve receives fuel from the metering unit. When fuel pressure reaches approximately 3.5 p.s.i., the valve opens and admits fuel to six ports in the manifold valve (one port for each fuel nozzle line). The manifold valve also serves to provide a clean cutoff of fuel to the cylinder when the engine is shut down.

The injector nozzle lines connect the manifold valve to the six fuel injector nozzles.

The injector nozzles (one per cylinder) are "air bleed" type fuel nozzles which spray fuel directly into the intake port of the cylinder. When the engine is running, flow through the nozzle is continuous and will enter the cylinder combustion chamber when the intake valve opens.

Since the size of the fuel nozzles is fixed, the amount of fuel flowing through them is determined by the pressure applied. For this reason, fuel flow may be accurately determined by measuring the pressure at the manifold valve.

All of the items described above are interdependent on each other to meter the correct amount of fuel according to the power being developed by the engine.

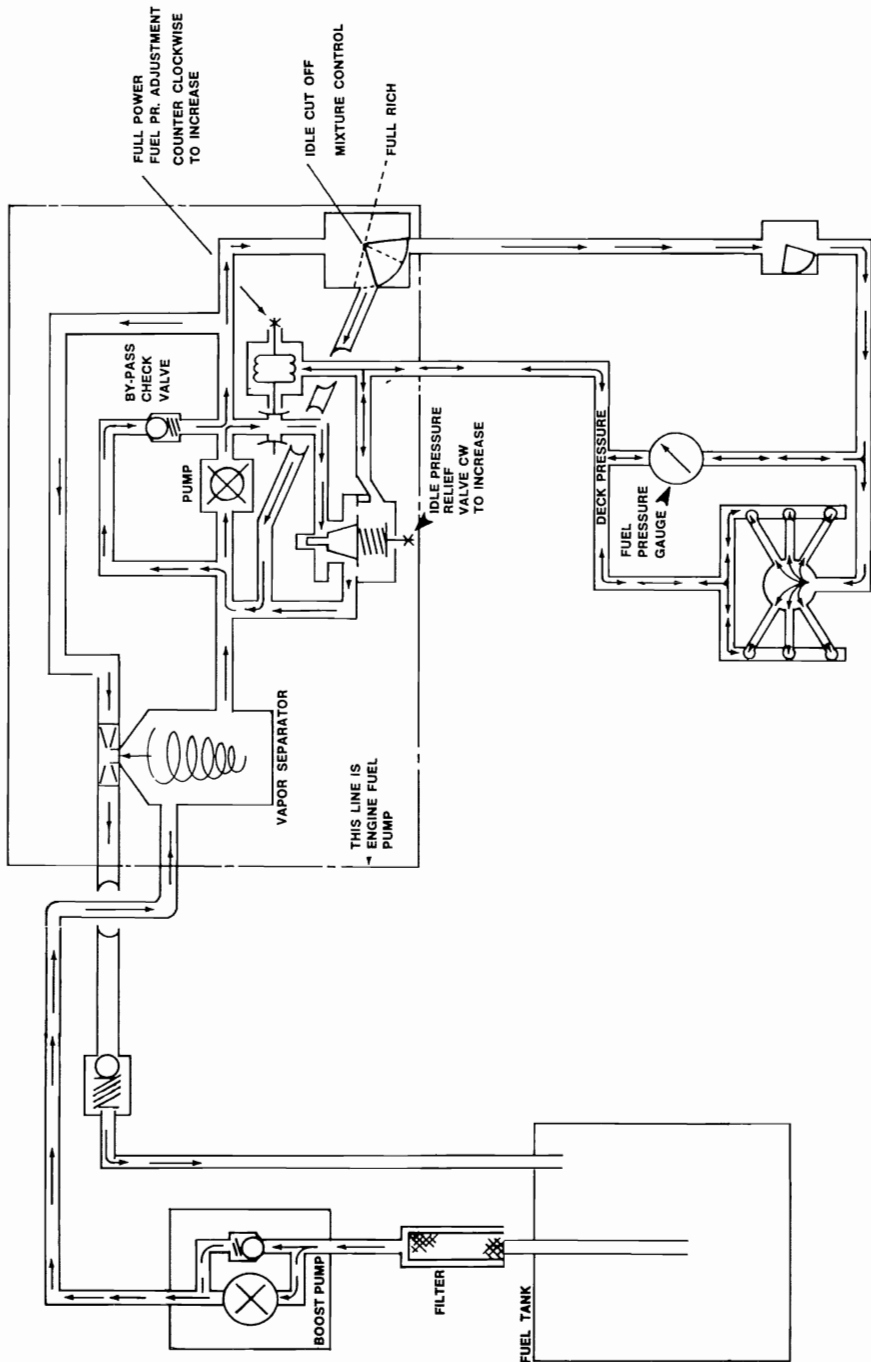

**FIGURE 67
FUEL SYSTEM SCHEMATIC**

TURBOCHARGING SYSTEM

The induction system components include the aircraft filter/alternate air door, turbocharger compressor, throttle, manifold tube and cylinder intake ports. Air flows through these components in the order they are listed.

The complete turbocharger system consists of a turbine and compressor assembly, wastegate assembly, necessary hose, and ducting required for a functional installation.

The filter normally accepts all incoming air from the aircraft intake scoop. Should the filter become blocked for any reason, the alternate air door will open to preclude engine stoppage.

The turbocharger compressor is a high volume air pump connected to the opposite end of the turbocharger turbine (see Turbocharger Figure 70). It increases the volume and pressure of air admitted to the cylinder for combustion. At high compressor discharge pressures, considerable heating of the induction air occurs, due to compression.

The intake manifold system is a six-tube, air distribution system mounted atop the engine. It serves to carry induction air to the individual cylinder intake ports.

The cylinder intake ports are cast into the cylinder head assembly. Air from the manifold tube is carried into the intake ports, mixed with fuel from the injector nozzles, and enters the cylinder as a combustible mixture when the intake valve opens.

Overboost protection is provided by a pressure relief valve located between the compressor and the throttle. The relief valve will open to prevent excessive manifold pressure.

The wastegate assembly on engine models E, EB, F, FB, GB & KB is a fixed orifice type, all other models use a variable control wastegate (Figure 71). When open, the valve allows exhaust gas to bypass the turbine and flow directly overboard. In the closed position, the wastegate valve diverts the exhaust gases into the turbine.

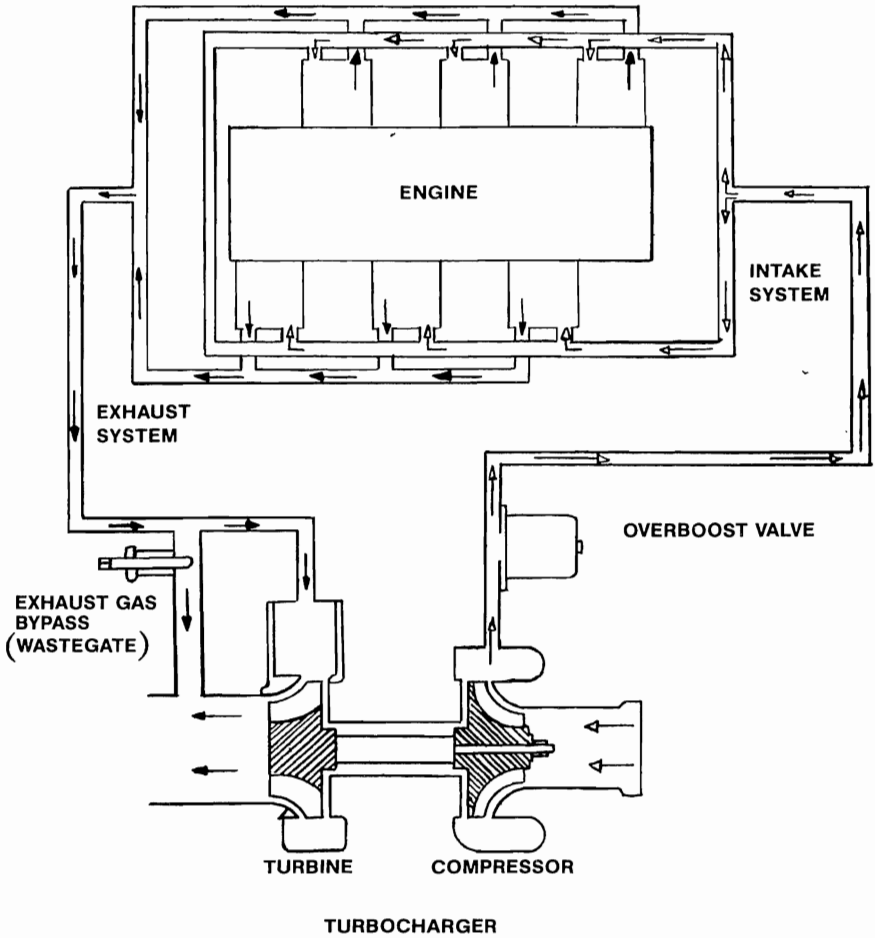
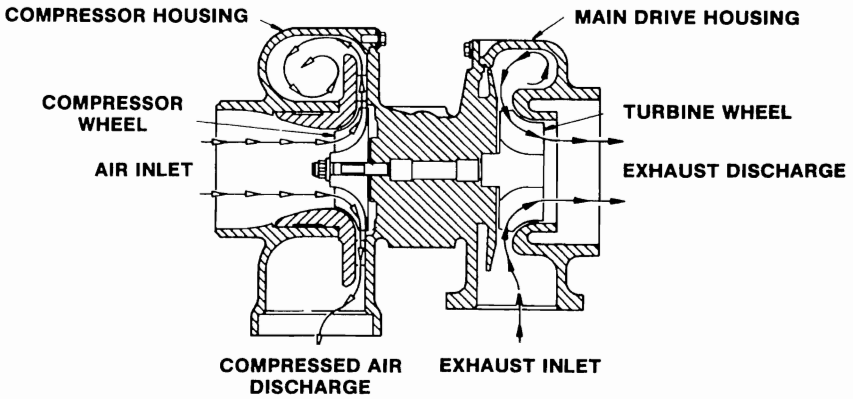
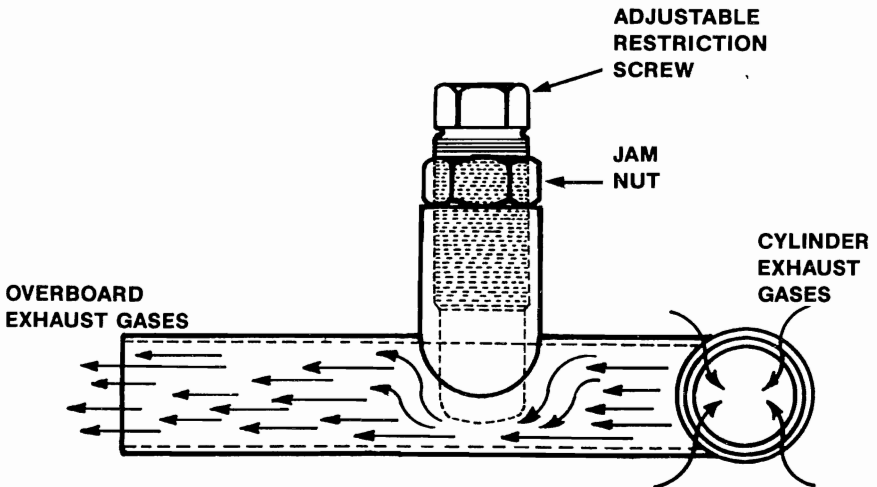

FIGURE 68
INDUCTION/EXHAUST SYSTEM SCHEMATIC



**FIGURE 69
TURBOCHARGER SECTIONAL**



**FIGURE 70
FIXED ORIFICE WASTEGATE
TSIO-360-F, FB, GB
L/TSIO-360-E, EB, KB**

CYLINDERS.

Before assembly, the aluminum cylinder heads are heated and screwed on to the steel alloy barrels. The nitralloy valve guides and seats are pressed into the hot cylinder head. When the entire unit has cooled, a permanent cylinder assembly results. The cylinders are then nitrided for hardening and zinc phosphate coated. The zinc phosphate coating has a gray-black visual appearance. This thin coating is oil absorbant to provide a moisture barrier to aid in the prevention of rust and corrosion. Replaceable helical coil inserts are installed in the spark plug ports.

VALVES.

Exhaust valves are faced with a special heat and corrosion-resistant material and the valve stems are chromed for wear resistance. Oil fed to the constant flow hydraulic valves lifters, under pressure from the main galleries, lubricates the lifter guide surfaces and fills the reservoirs inside the lifters. Oil from the lifters which reaches the pushrod ends flows through the pushrods to the rocker arms. Each rocker directs a portion of its oil through a nozzle towards the respective rotating valve stem. Oil is returned to the crankcase through the pushrod housings, which are sealed to the cylinder head and crankcase by rubber seals. Drain holes in the lifter guides direct returning oil to the sump.

PISTONS.

Pistons are aluminum alloy casting with a steel insert casted into the top ring groove. The skirts are solid and have cylindrical relief cuts at the bottom to clear the crankshaft counterweights. Pistons have three ring grooves above the pin and the groove below the pin hole (oil scraper). A center grooved and slotted oil ring is installed in the third groove, which has six oil drain holes to the interior. Piston pins are full floating ground steel tubes with permanently pressed-in end plugs.

IGNITION SYSTEM.

(a) Torque from the engine crankshaft is transmitted through the camshaft gear to the magneto drive gears, which in turn drives the magneto drive coupling. The magneto incorporates an impulse coupling. As the rubber bushings in the drive gear turns the coupling drive lugs, counterweighted latch pawls, inside the coupling cover, engage pins on the magneto case and hold back the latch plate until forced inward by the coupling cover. When the latch plate is released, the coupling spring spins the magneto shaft through its neutral position and the breaker opens to produce a high voltage surge in the secondary coil. The spring action permits the latch plate, magnet and breaker to be delayed through a lag angle of 30 degrees of drive gear rotation during the engine cranking period. Two lobes on the breaker cam produce two sparks per revolution of the drive shaft. After engine is started, counterweights hold the latch pawls away from the stop pins and the magneto shaft is driven at full advance.

(b) Engine firing order is 1-6-3-2-5-4 for the TSIO-360 Series and 1-4-5-2-3-6 for the LTSIO-360 Series (See Figure 101). As viewed from the distributor end, the TSIO-360 magneto turns counter-clockwise. The LTSIO-360 magneto rotor turns clockwise. Observe the position of the No. 1 cable terminal in the magneto outlet plate in relation to the magneto case. As the magneto rotor turns, it passes in succession the terminal of the spark plug cables in engine firing order. Cables are connected to the magnetos so that the right magneto fires the upper plugs on the right side and lower plugs on the left. The left magneto fires the upper spark plugs on the left side and the lower spark plugs on the right. The magneto cases, spark plugs, cables and connections are shielded to prevent radio interference.

PRESSURIZED MAGNETOS.

Some engine models are equipped with pressurized magnetos. Bleed air is tapped off of the throttle housing and is routed through tubes to a filter. From the air filter the pressurized bleed air is divided by a T-fitting and is routed to each magneto. The air pressure entering the magnetos is between 5-10 p.s.i. at normal operation.

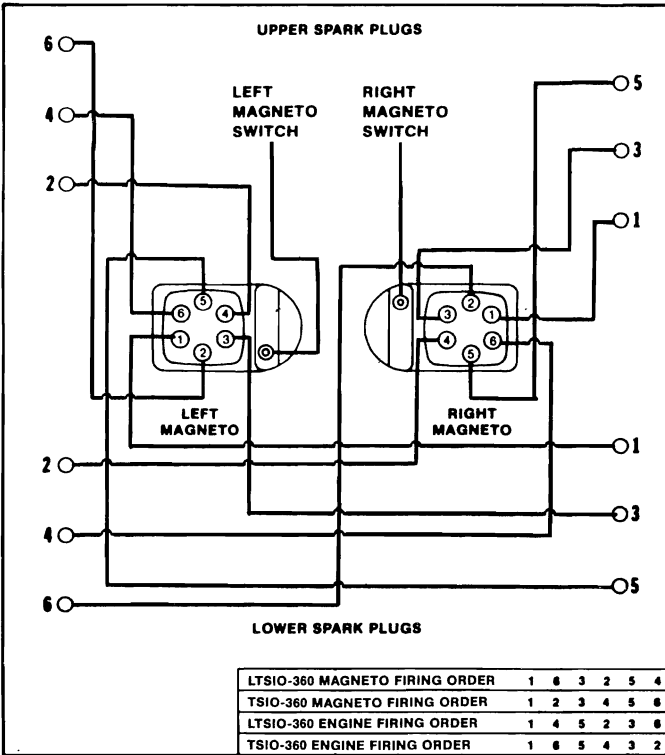

FIGURE 71
IGNITION WIRING DIAGRAM

SECTION VIII

SERVICING AND INSPECTION

SERVICING

Maximum efficiency and engine service life can be expected when a sound inspection program is followed. Poor maintenance results in faulty engine performance and reduced service life. Efficient engine operation demands careful attention to cleanliness of air, fuel, oil and maintaining operating oil temperatures within the required limits.

Good common sense is still the rule, but certain basic maintenance and operational requirements that we find widely disregarded, do determine to a large degree the service life of the modern aircraft engine.

Fuel (BLUE) 100LL or
(GREEN) Aviation Grade 100

WARNING . . . The use of a lower octane rated fuel can result in destruction of an engine the first time high power is applied. This would most likely occur on takeoff. If the aircraft is inadvertently serviced with the wrong grade of fuel, then the fuel must be completely drained and the tank properly serviced.

Oil: (First 25 hrs. operation) . . Mineral (non-Detergent oil or Corrosion Prevent oil - Corresponding to MIL-C-6529 Type II

AMBIENT AIR TEMPERATURE TO SELECT MULTI VISCOSITY GRADE OIL

<u>Below 40° F.</u>	<u>Above 40° F.</u>
<u>SAE #</u>	<u>SAE #</u>
30	50
10W-30	15W-50
15W-50	20W-50
20W-50	20W-50

Oil Sump Capacity:

- Models E,EB,F,FB,GB,KB 8 U.S. Quarts
- Models A,AB,B,BB,C,CB,D,DB,H,HB,J,JB . 10 U.S. Quarts

Oil level Oil levels are indicated by "High & Low" marks on oil level gauge

Oil Change Interval:

- With integral screen 25 Hrs.
- With small filter 50 Hrs.
- With large filter 100 Hrs.

Oil Filter Interval:

- With large or small filter 50 Hrs.

NOTE . . . The use of multi-viscosity oil is approved.

CAUTION . . . Use only oils conforming to Teledyne Continental Motors Specification MHS-24B after break-in period.

APPROVED PRODUCTS

The marketers of the aviation lubricating oils listed below have supplied data to Teledyne Continental Motors indicating their products conform to all requirements of TCM Specification MHS-24B, Lubricating Oil, Ashless Dispersant.

In listing the product names, TCM makes no claim or verification of marketer's statements or claims. Listing is made in alphabetical order and is provided only for the convenience of the users.

Supplier	Brand
BP Oil Corporation	BP Aero Oil
Castrol Limited (Australia)	Castrolaero AD Oil
Chevron U.S.A. Inc.	Chevron Aero Oil
Continental Oil	Conco Aero S
Delta Petroleum Company	Delta Avoil Oil
Exxon Company, U.S.A.	Exxon Aviation Oil EE
Gulf Oil Company	Gulfpride Aviation AD
Mobil Oil Company	Mobil Aero Oil
Mobil Oil Company	Mobil Aero Super Oil SAE 20W-50
Pennzoil Company	Pennzoil Aircraft Engine Oil
Phillips Petroleum Company	Phillips 66 Aviation Oil, Type A
Phillips Petroleum Company	X/C Aviation Multiviscosity Oil SAE 20W-50, SAE 20W-60
Quaker State Oil & Refining Co.	Quaker State AD Aviation Engine Oil
Turbo Resources Limited (Canada)	Red Ram Aviation Oil 20W-50
Shell Canada Limited	Aeroshell Oil W, Aeroshell Oil W 15W-50
Shell Oil Company	Aeroshell Oil W, Aeroshell Oil W, 15W-50
Sinclair Oil Company	Sinclair Avoil
Texaco Inc.	Texaco Aircraft Engine Oil - Premium AD
Union Oil Company of California	Union Aircraft Engine Oil HD

INSPECTIONS

The following procedures and schedules are recommended for engines which are subjected to normal operation. If the aircraft is exposed to severe conditions, such as training, extreme weather, or infrequent operation, inspections should be more comprehensive and the hourly intervals decreased.

DAILY INSPECTION (PREFLIGHT)

Before each flight the engine and propeller should be examined for damage, oil leaks, proper servicing and security. Ordinarily the cowling need not be opened for a daily inspection.

50 HOUR INSPECTION

Detailed information regarding adjustments, repair and replacement of components may be found in the appropriate Overhaul Manual. The following items should be checked during normal inspections.

1. Engine Conditions:	Magneto RPM drop:	Check
	Full Power RPM:	Check
	Full Power Manifold Pressure:	Check
	Full Power Fuel Flow:	Check
	Idle RPM:	Check

Record any values not conforming to engine specifications so that necessary repair or adjustment can be made.

2. Oil Filter: Replace filter, inspect cartridge.
3. Oil: Change oil, if integral screen or small filter is used.
4. Air Filter: Inspect and clean or replace as necessary.
5. High Tension Leads: Inspect for chafing and deterioration.
6. Magnetos: Check and adjust only if discrepancies were noted in Step 1.

- 7. Magneto Filter: Inspect for color, if white O.K., if red or contaminated, replace.
- 8. General: Visually check hoses, lines, wiring, fittings, baffles, etc. for general condition.
- 9. Exhaust System: Inspect for condition and leaks.
- 10. Adjustments & Repairs: Perform service as required on any items that are not within specifications.
- 11. Engine Conditions: Run up and check as necessary for any items serviced in Step 10. Check engine for oil and fuel leaks before returning to service.

100 HOUR INSPECTION

Perform all items listed under 50 Hour Inspection and add the following:

- 1. Oil: Drain while engine is warm. Refil sump.
- 2. Valves/Cylinders: Check compression. (Refer to Service Bulletin M73-19).
- 3. Cylinders, Fins, Baffles: Inspect.
- 4. Control Connections: Inspect and lubricate.
- 5. Fuel and Oil Hoses and Lines: Inspect for deterioration, leaks chafing.
- 6. Fuel Nozzles: Inspect nozzles and vent manifold for leaks or damage.

- 7. Turbocharger: Check freedom of rotation.
- 8. Exhaust: Pressure check all joints for condition and leaks.
- 9. Wastegate: Check operation and condition.
- 10. Alternate Air Door: Check operation.
- 11. Spark Plugs: Inspect, clean, regap (if necessary) and reinstall. Rotate plugs from upper to lower positions and vice versa to lengthen plug life.
- 12. Magnetos: Check. Adjust points and timing if necessary.

NOTE . . . Minor changes in magneto timing can be expected during normal engine service. The time and effort required to check and adjust the magnetos to specifications is slight and the operator will be rewarded with longer contact point and spark plug life, smoother engine operation and less corrective maintenance between routine inspections.

- 13. Oil Pressure Relief Valve: Inspect externally.
- 14. Oil Temperature Control Unit: Inspect and clean.
- 15. Fuel Metering Unit Inlet Screen: Inspect and clean.
- 16. Throttle and Mixture Linkage: Inspect for wear and lubricate.

- 17. High & Low Fuel
Pump Outlet
Pressure: Check. Adjust if necessary.

- 18. Adjustments &
Repairs: Perform service as required on any items
found defective.

- 19. Engine
Condition: Perform complete run-up. Check engine
for fuel or oil leaks before returning to
service.

NOTE . . . Refer to the Overhaul Manual for proper procedures and limits.

WARNING . . . Do not attempt to use this manual as a guide for performing repair or overhaul of the engine. The Engine Overhaul Manual must be consulted for such operations.

SECTION IX

TROUBLESHOOTING

The troubleshooting chart which follows, discusses symptoms which can be diagnosed and interprets the results in terms of probable causes and the appropriate corrective action to be taken.

For additional information on more specific troubleshooting procedures, refer to Maintenance and Overhaul Manual.

All engine maintenance should be performed by a qualified mechanic. Any attempt by unqualified personnel to adjust, repair or replace any parts may result in damage to the engine.

WARNING . . . Operation of a defective engine without a preliminary examination can cause further damage to a disabled component and possible injury to personnel. By careful inspection and troubleshooting, such damage and injury can be avoided and, in addition, the causes of faulty operation can be determined without excessive disassembly.

This troubleshooting chart is provided as a guide. Review all probable causes given, check other listings of troubles with similar symptoms. Items are presented in sequence of the approximate ease of checking, not necessarily in order of probability.

TROUBLE	PROBABLE CAUSE	CORRECTIVE ACTION
1. Engine will not start.	<ul style="list-style-type: none"> a. No fuel flow indications - No fuel to engine. b. Have fuel flow indications - Engine flooded. c. Have fuel flow indications - No fuel to engine. 	<ul style="list-style-type: none"> a. Check fuel quantity, then fuel control for proper position. Turn auxiliary pump "ON" in accordance with aircraft manufacturers instruction, and operating procedures. Have fuel filter checked. b. Turn off boost pump and ignition switch, set throttle to "FULL OPEN" and fuel control to "IDLE CUTOFF", and crank engine to clear cylinders of excess fuel. Repeat starting procedures. c. Check for bent or loose fuel lines.
2. Engine starts but fails to keep running.	<ul style="list-style-type: none"> a. Inadequate fuel to fuel manifold valve. b. Defective ignition system. 	<ul style="list-style-type: none"> a. Set fuel control in "FULL RICH" position, turn auxiliary pump "ON", check to be sure feed lines and filters are not restricted. Clean or replace defective components. b. Check accessible ignition cables and connections. Tighten loose connections. Replace defective spark plugs.

TROUBLE	PROBABLE CAUSE	CORRECTIVE ACTION
3. Engine runs rough at idle.	<ul style="list-style-type: none"> a. Improper idle mixture adjustment. b. Fouled spark plugs. c. Discharge nozzle air vent manifold restricted or defective. d. Restricted nozzle. 	<ul style="list-style-type: none"> a. Readjust idle setting. b. Remove and clean plugs, adjust gaps. Replace defective plugs. c. Check for bent or loose connections. Tighten loose connections. Check for restrictions and replace defective components. d. Remove and clean all nozzles.
4. Engine has poor acceleration.	<ul style="list-style-type: none"> a. Idle mixture too lean. b. Incorrect fuel/air mixture. c. Defective ignition system. 	<ul style="list-style-type: none"> a. Readjust idle setting. b. Tighten loose connections, replace worn elements of linkage. Service air cleaner. c. Check accessible ignition cables and connections. Replace defective spark plugs.

TROUBLE	PROBABLE CAUSE	CORRECTIVE ACTION
4. (Cont'd)	d. Malfunctioning Turbocharger.	d. Check operation, listen for unusual noise. Check operation of wastegate valve, and for exhaust system defects. Tighten loose connections.
5. Engine runs rough at speeds above idle	<p>a. Improper fuel/air mixture</p> <p>b. restricted fuel nozzle.</p> <p>c. Ignition system and spark plugs defective.</p>	<p>a. Check manifold connections for leaks. Tighten loose connections. Check fuel control and linkage for setting and adjustment. Check fuel filters and screens for dirt. Check for proper pump pressure, and replace pump if defective.</p> <p>b. Remove and clean all nozzles.</p> <p>c. Clean and regap spark plugs. Check cables for defects. Replace defective components.</p>

TROUBLE	PROBABLE CAUSE	CORRECTIVE ACTION
6. Engine lacks power, reduction in maximum manifold pressure or critical altitude.	<ul style="list-style-type: none"> a. Incorrectly adjusted throttle control, "sticky" linkage or dirty air cleaner. b. Defective ignition system c. Malfunctioning wastegate. d. Low oil pressure. e. Loose or damaged exhaust system. 	<ul style="list-style-type: none"> a. Check movement of linkage by moving control from idle to full throttle. Make proper adjustments and replace worn components. Service air cleaner b. Inspect spark plugs for fouled heavy carbon deposits, erosion or improperly adjusted electrode gaps and cracked porcelain. Test plugs for regular firing under pressure. Replace damaged or misfiring plugs. Check for proper spark plug gap. c. Check for full travel of wastegate valve. d. Adjust oil pressure relief valve to maintain 30 - 60 psi limit. e. Inspect entire exhaust system to turbocharger for cracks and leaking connections. Inspect gaskets at cylinder exhaust ports, and gasket at turbine inlet flange. Tighten connections and replace damaged parts.

TROUBLE	PROBABLE CAUSE	CORRECTIVE ACTION
6. (Cont'd)	f. Loose or damaged manifolding.	f. Inspect entire manifold system for possible leakage at connections. Replace damaged components, tighten all connections and clamps.
	g. Fuel nozzles defective.	g. Inspect fuel nozzle vent manifold for leaking connections. Tighten and repair as required. Check for restricted nozzles and lines and clean and replace as necessary.
	h. Malfunctioning turbocharger.	h. Check for unusual noise in turbocharger. If malfunction is suspected, remove exhaust and/or air inlet connections and check rotor assembly for possible rubbing in housing, damaged rotor or defective bearings. Replace turbocharger if damage is noted.

TROUBLE	PROBABLE CAUSE	CORRECTIVE ACTION
7. Low fuel flow.	<p>a. Restricted flow to fuel metering valve.</p> <p>b. Fuel nozzle vent system defective causing improper pressure regulation.</p>	<p>a. Check mixture control for full travel. Check for restrictions in fuel filters and lines, adjust control and clean filters. Replace damaged parts.</p> <p>b. Check venting system for leaks at connections and other defects. Tighten connections and replace defective parts.</p>
	<p>c. Improper rigging of aircraft linkage.</p> <p>d. Incorrect fuel injection pump adjustment and operation.</p>	<p>c. Adjust.</p> <p>d. Check and adjust using appropriate equipment. Replace defective pumps.</p>
	<p>e. Defective fuel injector pump relief valve.</p> <p>f. Air leakage in fuel pump pressurization line.</p>	<p>e. Clean or replace pump.</p> <p>f. Locate cause of leakage and correct.</p>
	<p>g. Injector fuel inlet strainer plugged.</p>	<p>g. Remove strainer and clean in a solvent. Acetone or MEK is recommended.</p>

TROUBLE	PROBABLE CAUSE	CORRECTIVE ACTION
7. (Cont'd)	<ul style="list-style-type: none"> h. Injector out of adjustment. i. Faulty fuel flow gauge. 	<ul style="list-style-type: none"> h. Replace injector. i. Install accurately calibrated gauge to verify faulty aircraft gauge. Replace as necessary.
8. High fuel flow.	<ul style="list-style-type: none"> a. Loose lines or fittings. b. Damaged nozzle if high fuel flow is accompanied by loss of power and roughness. c. Faulty fuel flow gauge. d. Injector out of adjustment. e. High fuel pressure. f. Air leakage in fuel gauge vent pressurization line. 	<ul style="list-style-type: none"> a. Tighten all connections and check for fuel stains. b. Remove and check. c. Replace if necessary. d. Replace injector. e. Check boost pump and engine fuel pump outlet pressure. f. Locate cause of leakage and eliminate.

TROUBLE	PROBABLE CAUSE	CORRECTIVE ACTION
9. Fluctuating fuel flow.	a. Vapor in fuel system, excess fuel temperature.	a. Normally operating the boost pump will clear systems. Operate boost pump and purge system.
10. Low oil pressure on engine gauge.	a. Insufficient oil in oil sump, oil dilution or using improper grade oil for prevailing ambient temperature.	a. Add oil or change oil to proper viscosity.
	b. High oil temperature.	b. Defective oil temperature control unit in oil cooler restriction. Replace valve or clean oil cooler.
	c. Leaking, damaged or loose oil line connections - Restricted screens and filter.	c. Check for restricted lines and connections, partially plugged oil filter and screens. Clean parts, tighten connections and replace defective parts.
11. Poor engine idle cutoff.	a. Engine getting fuel.	a. Check fuel control for being in full "IDLE CUTOFF" position. Check boost pump for being "OFF". Check for leaking fuel manifold valve. Replace defective components.

TROUBLE	PROBABLE CAUSE	CORRECTIVE ACTION
11. (Cont'd)	<ul style="list-style-type: none"> b. Improper rigging of aircraft linkage to mixture control. 	<ul style="list-style-type: none"> b. Adjust.
12. White smoke exhaust	<ul style="list-style-type: none"> a. Turbo coking, oil forced through seal turbine housing. 	<ul style="list-style-type: none"> a. Clean or change turbocharger.
13. High fuel flow at altitude.	<ul style="list-style-type: none"> a. Nozzle vent system leaking air. b. Defective fuel control. 	<ul style="list-style-type: none"> a. Air check for leaks, tighten or replace defective parts. b. Change fuel control.
14. Low fuel flow at altitude.	<ul style="list-style-type: none"> a. Fuel pump vent system leaking air. b. Defective fuel control. 	<ul style="list-style-type: none"> a. Air check for leaks, tighten or replace defective parts. b. Change fuel control.

SECTION X

STORAGE AND REMOVAL FROM STORAGE (ENGINE PRESERVATION FOR ACTIVE AND STORED AIRCRAFT)

TCM has listed three reasonable minimum preservation procedures, that if implemented, will minimize the detriments of rust and corrosion. It is the owner's responsibility to choose a preservation program that is viable to the particular aircraft's mission.

In all geographical areas the best method of preventing corrosion of the cylinders and other internal parts of the engine, is to fly the aircraft at least once a week, long enough to reach normal operating temperatures which will vaporize moisture and other by-products of combustion. This is even more important in areas of high humidity or when the aircraft is based near the sea coast where instances of corrosion in cylinders has been found after an inactive period of only a few days.

Engines with less than 50 hours total time in service, and engines in aircraft that are flown only occasionally, compared to frequent flying, when exposed to normal atmospheric conditions will tend to exhibit cylinder wall corrosion in a relatively short period of time if they are not properly preserved. This would also apply to engines with new or freshly honed cylinders after a top or major overhaul. Preservation must be initiated within five days after delivery and for these first 50 hours, SPECIAL attention should be followed according to the engine preservation procedures established under Program I, "Flyable Storage".

After the accumulation of 50 engine operating hours, a slight varnish deposit on the cylinder walls offers some protection against corrosion, but also engine preservation procedures as outlined under Program II, "Flyable Storage" should be followed. If you follow these procedures or frequently use your aircraft, it is very unlikely you will have any problems. If problems do arise, verify compliance with the procedures outlined in these programs.

If the aircraft will be stored or statically displayed for an undetermined period of time, the engine must be preserved in accordance with the "Temporary" or "Indefinite" storage procedures as fits your purpose, listed in this section.

Aircraft engine storage recommendations are broken down into the following categories:

FLYABLE STORAGE (Program I or II)
TEMPORARY STORAGE (up to 90 days)
INDEFINITE STORAGE

FLYABLE STORAGE (Program I or II)

Program I - Engines or cylinders with less than 50 operating hours:

- a. Propeller pull thru every 5 days as per paragraph 2; and
- b. Fly every 15 days as per paragraph 3.

Program II - Engines or cylinders with more than 50 operating hours to TBO if not flown weekly:

- a. Propeller pull thru every 7 days as per paragraph 2; and
- b. Fly every 30 days as per paragraph 3.

1. Service aircraft per normal airframe manufacturer's instructions.

2. The propeller should be rotated by hand without running the engine. For 4 and 6 cylinder straight drive engines, rotate the engine six revolutions, stop the propeller 45° to 90° from the original position. For 6 cylinder geared engines, rotate the propeller 4 revolutions and stop the propeller 30° to 60° from the original position.

CAUTION . . . FOR MAXIMUM SAFETY, ACCOMPLISH ENGINE ROTATION AS FOLLOWS:

- a. Verify magneto switches are "OFF"
- b. Throttle position "CLOSED"
- c. Mixture control "IDLE CUT-OFF"
- d. Set brakes and block aircraft wheels
- e. Leave aircraft tie-downs installed and verify that the cabin door latch is open.
- f. Do not stand within the arc of the propeller blades while turning the propeller.

3. The aircraft should be flown for thirty (30) minutes, reaching, but not exceeding, normal oil and cylinder temperatures. If the aircraft cannot be flown it should be preserved per "Temporary Storage" or "Indefinite Storage", accordingly. Ground running is not an acceptable substitute for flying.

NOTE . . . If "b." in each program cannot be accomplished on schedule due to weather, maintenance, etc., pull the propeller thru daily and accomplish as soon as possible.

It is necessary that for future reference, if required, the propeller pull thru and flight time be recorded and verified in the engine maintenance record/log with the date, time and signature.

TEMPORARY STORAGE (up to 90 days)

Preparation for Storage

1. Remove the top spark plug and spray preservative oil (Lubrication Oil - Contact and Volatile Corrosion - Inhibited, MIL-L-46002, Grade 1) at room temperature, through upper spark plug hole of each cylinder with the piston in approximately the bottom dead center position. Rotate crankshaft as each pair of opposite cylinders is sprayed. Stop crankshaft with no piston at top dead center. A pressure pot or pump-up type garden pressure sprayer may be used. The spray head should have ports around the circumference to allow complete coverage of the cylinder walls.

NOTE . . . Shown below are some approved preservative oils recommended for use in Teledyne Continental engines for temporary and indefinite storage:

MIL-L-46002, Grade 1 Oils:

NOX RUST VCI-105 Daubert Chemical Company
4700 S. Central Avenue
Chicago, Illinois

PETROTECT VA Pennsylvania Refining Company
Butler, Pennsylvania

2. Re-spray each cylinder without rotating crank. To thoroughly cover all surfaces of the cylinder interior, move the nozzle or spray gun from the top to the bottom of the cylinder.
3. Re-install spark plugs.
4. Apply preservative to engine interior by spraying the above specified oil (approximately two ounces) through the oil filler tube.
5. Seal all engine openings exposed to the atmosphere using suitable plugs, or moisture resistant tape, and attach red streamers at each point.
6. Engines, with propellers installed, that are preserved for storage in accordance with this section should have a tag affixed to the propeller in a conspicuous place with the following notation on the tag: "DO NOT TURN PROPELLER - ENGINE PRESERVED", with the preservation date.

NOTE . . . If the engine is not returned to flyable status at the expiration of the Temporary (90 day) Storage, it must be preserved in accordance with the Indefinite Storage procedures.

Preparation for Service

1. Remove seals, tape, paper and streamers from all openings.
2. With bottom spark plugs removed from the cylinders, hand turn propeller several revolutions to clear excess preservative oil, then re-install spark plugs.
3. Conduct normal start-up procedure.
4. Give the aircraft a thorough cleaning and visual inspection. A test flight is recommended.

INDEFINITE STORAGE

Preparation for Storage

1. Drain the engine oil and refill with MIL-C-6529 Type II. Start engine and run until normal oil and cylinder head temperatures are reached. The preferred method would be to fly the aircraft for thirty (30) minutes. Allow engine to cool to ambient temperature. Accomplish steps 1 and 2 of "Temporary Storage".

NOTE . . . MIL-C-6529 Type II may be formulated by thoroughly mixing one part compound MIL-C-6529 Type I (Esso Rust-Ban 628, Cosmoline No. 1223 or equivalent) with three parts new lubricating oil of the grade recommended for service (all at room temperature). Single grade oil is recommended.

2. Apply preservative to engine interior by spraying MIL-L-46002, Grade 1 oil (approximately two ounces) through the oil filler tube.
3. Install dehydrator plugs MS27215-1 or -2, in each of the top spark plug holes, making sure that each plug is blue in color when installed. Protect and support the spark plug leads with AN-4060 protectors.

4. If the engine is equipped with a pressure type carburetor, preserve this component by the following method. Drain the carburetor by removing the drain and vapor vent plugs from the regulator and fuel control unit. With the mixture control in "Rich" position, inject lubricating oil Grade 1010 into the fuel inlet at a pressure not to exceed 10 p.s.i. until oil flows from the vapor vent opening. Allow excess oil to drain, plug the inlet and tighten and safety the drain and vapor vent plugs. Wire the throttle in the open position, place bags of desiccant in the intake and seal the opening with moisture resistant paper and tape, or a cover plate.
5. If the carburetor is removed from the engine, place a bag of desiccant in the throat of the carburetor air adapter. Seal the adapter with moisture resistant paper and tape, or a cover plate.
6. The TCM fuel injection system does not require any special preservation preparation. For preservation of the Bendix RSA-7DA-1 fuel injection system, refer to the Bendix Operation and Service Manual.
7. Place a bag of desiccant in the exhaust pipes and seal the openings with moisture resistant tape.
8. Seal the cold air inlet to the heater muff with moisture resistant tape to exclude moisture and foreign objects.
9. Seal the engine breather by inserting a dehydrator MS27215-2 plug in the breather hose and clamping in place.
10. Attach a red streamer to each place on the engine where bags of desiccant are placed. Either attach red streamers outside of the sealed area with tape or to the inside of the sealed area with safety wire to prevent wicking of moisture into the sealed area.
11. Engines, with propellers installed, that are preserved for storage in accordance with this section should have each propeller tagged in a conspicuous place with the following notation on the tag: "DO NOT TURN PROPELLER - ENGINE PRESERVED", with the preservation date.

RETURNING AN AIRCRAFT TO SERVICE PROCEDURES:

1. Remove the cylinder dehydrator plugs and all paper, tape, desiccant bags and streamers used to preserve the engine.
2. Drain the corrosion preventive mixture and re-service with recommended lubricating oil.

WARNING . . . When returning the aircraft to service do not use the corrosion preventive oil referenced in "INDEFINITE STORAGE", paragraph 1 for more than 25 hours.

3. If the carburetor has been preserved with oil, drain it by removing the drain and vapor vent plugs from the regulator and fuel control unit. With the mixture control in "Rich" position, inject service type gasoline into the fuel inlet at a pressure not to exceed 10 p.s.i. until all of the oil is flushed from the carburetor. Re-install the carburetor plugs and attach the fuel line.
4. With bottom plugs removed, rotate propeller to clear excess preservative oil from cylinders.
5. Re-install the spark plugs and rotate the propeller by hand through the compression strokes of all the cylinders to check for possible liquid lock. Start the engine in the normal manner.
6. Give the aircraft a thorough cleaning, visual inspection and test flight per airframe manufacturer's instructions.

INSPECTION OF AIRCRAFT STORED PER INDEFINITE STORAGE PROCEDURES:

1. Aircraft prepared for indefinite storage should have the cylinder dehydrator plugs visually inspected every 15 days. The plugs should be changed as soon as their color indicates unsafe conditions of storage. If the dehydrator plugs have changed color in one-half or more of the cylinders, all desiccant material on the engine should be replaced.

2. The cylinder bores of all engines prepared for indefinite storage should be re-sprayed with corrosion preventive mixture every six months, or more frequently if bore inspection indicates corrosion has started earlier than six months. Replace all desiccant and dehydrator plugs. Before spraying, the engine should be inspected for corrosion as follows: Inspect the interior of at least one cylinder on each engine through the spark plug hole. If cylinder shows start of rust, spray cylinder corrosion preventive oil and turn prop over six times, then re-spray all cylinders. Remove at least one rocker box cover from each engine and inspect the valve mechanism.

SECTION XI

GLOSSARY

ADMP - Absolute dry manifold pressure. It is used in establishing base-line standards of engine performance. Manifold pressure is the absolute pressure in the intake manifold; it is expressed in inches of mercury ("Hg).

AMBIENT - A term used to denote a condition of the surrounding atmosphere at a particular time. For example: Ambient Temperature or Ambient Pressure.

BHP - Brake Horsepower. The power actually delivered to the engine propeller shaft. It is so called because it was formerly measured by applying a brake to the power shaft of an engine. The required effort to brake the engine could be converted to horsepower - hence: "Brake" horsepower.

BSFC - Brake Specific Fuel Consumption. Fuel consumption stated in pounds per hour per brake horsepower. For example, an engine developing 200 horsepower while burning 100 pounds of fuel per hour, has a BSFC of .5.

$$\frac{\text{Fuel consumption in PPH}}{\text{Brake horsepower}} = \frac{100}{200} = .5$$

COLD SOAKING - Prolonged exposure of an object to cold temperatures so that its temperature throughout approaches that of ambient.

CRITICAL ALTITUDE - The maximum altitude at which a component can operate at 100% capacity. For example, an engine with a critical altitude of 16,000 feet cannot produce 100% of its rated manifold pressure above 16,000 feet.

DENSITY ALTITUDE - The effective altitude, based on prevailing temperature and pressure, equivalent to some standard pressure altitude.

DYNAMIC CONDITION - A term referring to properties of a body in motion.

E.G.T. - Exhaust Gas Temperature. Measurement of this gas temperature is sometimes used as an aid to fuel management.

EXHAUST BACK PRESSURE - Opposition to the flow of exhaust gas, primarily caused by the size and shape of the exhaust system. Atmospheric pressure also affects back pressure.

FOUR CYCLE - Short for "Four Stroke Cycle". It refers to the four strokes of the piston in completing a cycle of engine operation (Intake, Compression, Power and Exhaust).

FUEL INJECTION - A process of metering fuel into an engine by means other than a carburetor.

GALLERY - A passageway in an engine or component. Especially one through which oil is flowed.

Hg" - Inches of Mercury. A standard for measuring pressure, especially atmospheric pressure or manifold pressure.

HEAT SOAKED - Prolonged exposure of an object to hot temperature so that its temperature throughout approaches that of ambient.

HUMIDITY - Moisture in the atmosphere. Relative humidity, expressed in percent, is the amount of moisture (water vapor) in the air compared with the maximum amount of moisture the air could contain at a given temperature.

LEAN LIMIT MIXTURE - The leanest mixture permitted for any given power condition. It is not necessarily the leanest mixture at which the engine will run.

MANIFOLD PRESSURE - Absolute pressure as measured in the intake manifold. Usually measured in inches of mercury.

MIXTURE - Mixture Ratio. The proportion of fuel to air used for combustion.

NATURALLY ASPIRATED (ENGINE) - A term used to describe an engine which obtains induction air by drawing it directly from the atmosphere into the cylinder. A nonsupercharged engine.

NATURALLY ASPIRATED (ENGINE) - A term used to describe an engine which obtains induction air by drawing it directly from the atmosphere into the cylinder. A nonsupercharged engine.

NRP - Normal Rated Power.

O.A.T. - Outside Air Temperature.

OCTANE NUMBER - A rating which describes relative anti-knock (detonation) characteristics of fuel. Fuels with greater detonation resistance than 100 octane are given Performance Ratings.

OIL TEMPERATURE CONTROL UNIT - A thermostatic unit used to divert oil through or around the oil cooler, as necessary, to maintain oil temperature within desired limits.

OVERBOOST VALVE - A safety device used on some turbo-charged engines to relieve excessive manifold pressure in event of a malfunction.

OVERHEAD VALVES - An engine configuration in which the valves are located in the cylinder head itself.

OVERSPEED - When an engine has exceeded its rated revolutions per minute.

PERFORMANCE RATING - A rating system used to describe the ability of fuel to withstand heat and pressure of combustion as compared with 100 octane fuel. For example, an engine with high compression and high temperature needs a higher Performance Rated fuel than a low compression engine. A rating of 100/130 denotes performance characteristics of lean (100) and rich (130) mixtures respectively.

PRESSURE ALTITUDE - Altitude, usually expressed in feet, (using absolute pressure (static) as a reference) equivalent to altitude above the standard sea level reference plane (29.92" Hg).

PROPELLER LOAD CURVE - A plot of horsepower, fuel flow, or manifold pressure versus RPM through the full power range of one engine using a fixed pitch propeller or a constant speed propeller running on the low pitch stops. This curve is established or determined during design and development of the engine.

PROPELLER PITCH - The angle between the mean chord of the propeller and the plane of rotation.

RAM - Increased air pressure due to forward speed.

RATED POWER - The maximum horsepower at which an engine is approved for operation. Rated power may be expressed in horsepower or percent.

RETARD BREAKER - A device used in magnetos to delay ignition during cranking. It is used to facilitate starting.

RICH LIMIT - The richest fuel/air ratio permitted for any given power condition. It is not necessarily the richest condition at which the engine will run.

ROCKER ARM - A mechanical device used to transfer motion from the pushrod to the valve.

SCAVENGE PUMP - A pump (especially an oil pump) to prevent accumulation of liquid in some particular area.

SONIC VENTURI - A restriction, especially in cabin pressurization systems, to limit the flow of air through a duct.

STANDARD DAY - By general acceptance, temperature - 59°F/15°C, pressure - 29.92 In. Hg.

STATIC CONDITION - A term referring to properties of a body at rest.

SUMP - The lowest part of a system. The main oil sump on a wet sump engine contains the oil supply.

TBO - Time Between Overhauls. Usually expressed in operating hours.

T.D.C. - Top Dead Center. The position in which the piston has reached the top of its travel. A line drawn between the crankshaft rotational axis, through the connecting rod end axis and the piston pin center would be a straight line. Ignition and valve timing are stated in terms of degrees before or after TDC.

THERMAL EFFICIENCY - Regarding engines, the percent of total heat generated which is converted into useful power.

T.I.T. - Turbine Inlet Temperature. The measurement of E.G.T. at the turbocharger turbine inlet.

TORQUE - Twisting moment or leverage, stated in pounds-foot (or pounds-inch).

TURBOCHARGER - A device used to supply increased amounts of air to an engine induction system. In operation, a turbine is driven by engine exhaust gas. In turn, the turbine directly drives a compressor which pumps air into the engine intake.

VAPOR LOCK - A condition in which the proper flow of a liquid through a system is disturbed by the formation of vapor. Any liquid will turn to vapor if heated sufficiently. The amount of heat required for vaporization will depend on the pressure exerted on the liquid.

VARIABLE PRESSURE CONTROLLER - A device used to control the speed, and thus the output of the turbocharger. It does so by operating the wastegate which diverts, more or less, exhaust gas over the turbine.

VISCOSITY - The characteristic of a liquid to resist flowing. Regarding oil, high viscosity refers to thicker or "heavier" oil while low viscosity oil is thinner. Relative viscosity is indicated by the specific "weight" of the oil such as 30 "weight" or 50 "weight". Some oils are specified as multiple-viscosity such as 10W30. In such cases, this oil is more stable and resists the tendency to thin when heated or thicken when it becomes cold.

VOLATILITY - The tendency of a liquid to vaporize.

VOLUMETRIC EFFICIENCY - The ability of an engine to fill its cylinders with air compared to their capacity for air under static conditions. A "normally aspirated" engine will always have a volumetric efficiency of slightly less than 100%, whereas superchargers permit volumetric efficiencies in excess of 100%.

WASTEGATE VALVE - A unit, used on turbocharged engines, to divert exhaust gas through or around the turbine, as necessary to maintain turbine speed. As more air is demanded by the engine, due to throttle operation, the compressor must work harder. In order to maintain compressor and turbine speed, more exhaust must be flowed through the turbine. The wastegate valve closes and causes gas, which would go directly overboard, to pass through the turbine. The wastegate is usually operated by an actuator which gets signals from the turbocharger controller.



TM